



pacifi**CH**ARDWOOD

We Measure Up

Pacific Hardwood provides hardwood lumber, moulding, and flooring to commercial customers. Cabinet shops, design firms, architects, lumber yards, millwork shops, and the furniture industry represent the many kinds of businesses served by our company.

With headquarters in Orange County, Pacific Hardwood operates a modern, well equipped hardwood yard and millwork facility with daily truck and rail shipments throughout the country. Our principal focus is the timely delivery of superior material to the many customers whose manufacturing and business efforts we support.

At Pacific Hardwood, we welcome the challenge of competition in the dynamic and growing Southern California marketplace. We are especially proud of the skilled and dedicated personnel who are the principal asset of our company. We pride ourselves on operating an agile and customer-friendly organization, and we continually reevaluate both ourselves and our suppliers toward the goal of delivering the best possible hardwood lumber, moulding, flooring, and millwork, all on time and at the lowest possible price.

We sincerely appreciate your interest in Pacific Hardwood. Please call our office with any questions you may have regarding our products or services. We invite you to join our many satisfied customers, and we pledge our diligent effort toward the satisfaction of your requirements. If our customers look good, we look good. It's that simple.

PH 714.998.6446

Fx 714.998.6260

www.pacifichardwood.com



pacificHARDWOOD
We Measure Up



Pacific Hardwood proudly maintains active membership in industry trade organizations whose mission is to promote uniform and accurate grading and quality, and to preserve our natural resources.

PH 714.998.6446

Fx 714.998.6260

Products and Services

Hardwood Lumber

- ▶ Domestic and imported lumber
- ▶ Over 30 species in stock
- ▶ Plain, quarter and rift sawn
- ▶ Long lengths up to 16'
- ▶ 4/4 through 16/4
- ▶ Specializing in thick stock
- ▶ On site millwork
- ▶ Longstanding connections with top quality hardwood sources throughout the united states and overseas

Mouldings

- ▶ Thicknesses to 3" x 12"
- ▶ Nationwide shipping
- ▶ Custom or catalog patterns
- ▶ Random lengths or cut-to-length
- ▶ Sanding, priming & other services available
- ▶ Modern & efficient state-of-the-art equipment

Flooring

- ▶ Wide plank, up to 12"
- ▶ Combination face widths
- ▶ Long lengths up to 16'
- ▶ Rustic & character grade
- ▶ Numerous grades
- ▶ Domestic & imported species
- ▶ Plain, rift-sawn or quarter-sawn
- ▶ Standard & custom thicknesses
- ▶ Custom millwork our speciality
- ▶ Matching mouldings & lumber
- ▶ End match any length

Professional & Experienced Service

- ▶ Conveniently located
- ▶ Rapid order fulfillment
- ▶ Experienced personnel
- ▶ Extensive lumber inventory
- ▶ Very competitive pricing
- ▶ High standards in manufacturing

Partial Lumber Inventory List

- ▶ Alder
- ▶ Ash
- ▶ Beech
- ▶ Birch
- ▶ Butternut
- ▶ Cherry
- ▶ Fir
- ▶ Hickory/ Pecan
- ▶ Jatoba
- ▶ Koa
- ▶ Mahogany
- ▶ Maple
- ▶ Pine
- ▶ Raintree
- ▶ On Site Millwork
- ▶ Red oak
- ▶ Walnut
- ▶ OWhite Oak
- ▶ All Popular Imports
- ▶ Numerous Other Domestics

Millwork Capabilities

- ▶ Sanded panels
- ▶ Drum sanded flat stock
- ▶ Manufactured flooring
- ▶ Radius work
- ▶ Pacific hardwood maintains active relationships with numerous production and millwork facilities throughout the United States. Whatever your need for wood parts, lumber, finished products, or millwork services, we can provide the services and materials you require.

Complete Packages

- ▶ Complete milling of all required moulding and lumber details for construction projects. We work directly from prints to provide all scheduled wood requirements

About Mouldings

Pacific Hardwood produces moulding details on a special order basis. We are happy to quote on any quantity, however, production and set-up costs generally restrict the manufacture of small quantities. We can provide quotations from drawings faxed to our location, or by reference to any of the details in this catalog. We are happy to call on you at your location to discuss your requirements. Keep in mind that the profiles shown on these pages are only a representative sample of popular details. Our skilled milling department can duplicate virtually any moulding detail within the constraints of our equipment, and we take pride and pleasure in satisfying your individual requirements.

Please remember that your choice of wood species can dramatically affect production costs. Also, certain species are better suited to the production of long lengths or other special requirements. Hardwood mouldings are most often produced in American red oak, white oak, maple, poplar, birch, walnut, alder, and mahogany. Softwood mouldings are produced in pine and Douglas fir. These species are stocked and orders can generally be filled quickly.

Drawings in this catalog are approximately full size. Actual moulding details may vary from these drawings. Different runs of the same moulding detail may vary. Moulding runs are produced and delivered subject to industry grading rules. Our sales staff will be happy to carefully review all aspects of moulding production. We sincerely appreciate your business.



pacificHARDWOOD

We Measure Up

Table of Contents

Base	6-11
Base Cap	12
Base Shoe	8
Casing	14-20
Chair Rail	21-23
Cove	24
Crown	25-33
Drawer Sides	34
Flooring	35-36
Fluting/ Beading	37-39
Half Round	40
Hand Rail	41-45
Jamb	47-48
Lattice	50
Nosing	51-53
Outside Corner	24
Panel Moulding	54-55
Quarter Round	24
Reducer	58
Rounds	56
S4S	57
Shoe Rail/ Filet	46
Sill	49
Door Stop	49
Threshold	59-60
Cap, Wainscot Cap	13
Wall Paneling	61
Index	62-67

PH 714.998.6446

Fx 714.998.6260

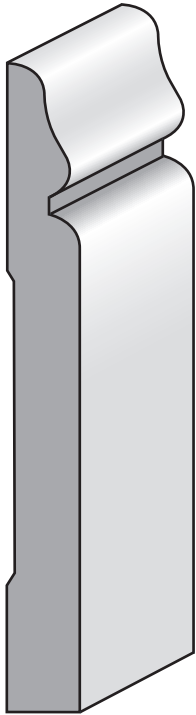

PAC 2107
3/8 X 3-3/8

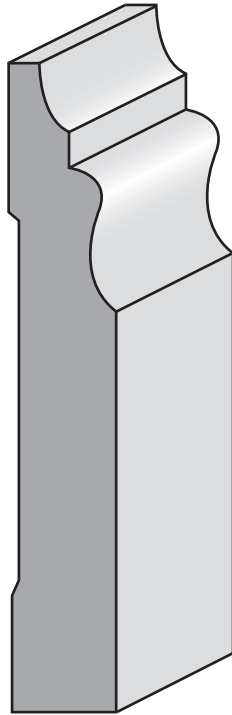

PAC 2110
9/16 X 3-3/8

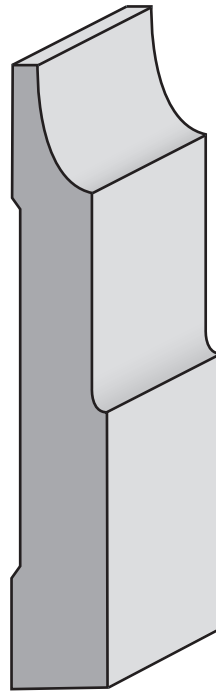

PAC 2111
1/2 X 3-1/2

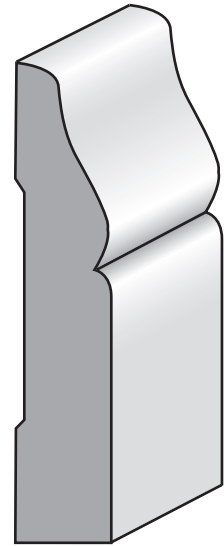

PAC 2100
1/2 X 2-1/2

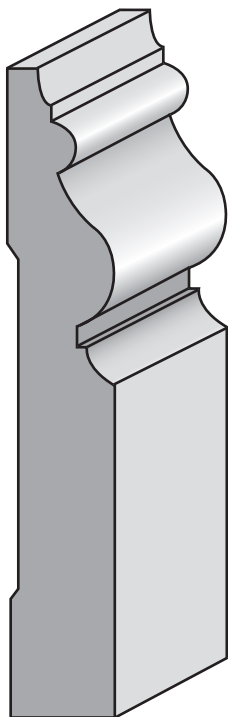

PAC 2109
9/16 X 3-3/8

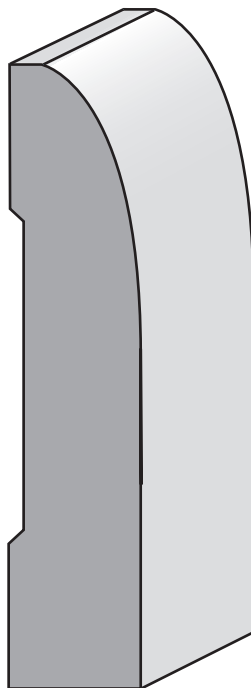

PAC 2103
11/16 X 3-1/4

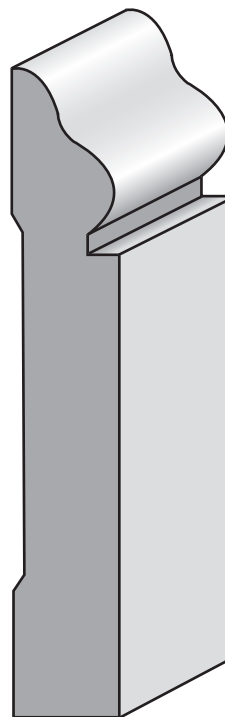

PAC 2108
9/16 X 3-3/8

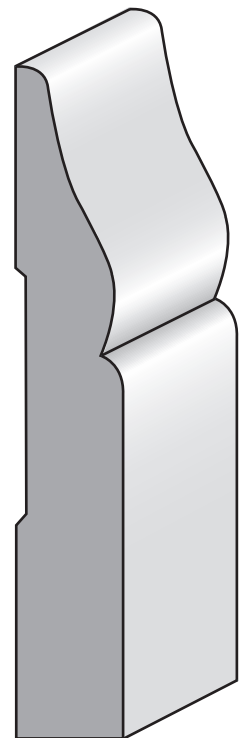

PAC 2113 6
9/16 X 3-1/2



pacifi**C**HARDWOOD

We Measure Up

Base

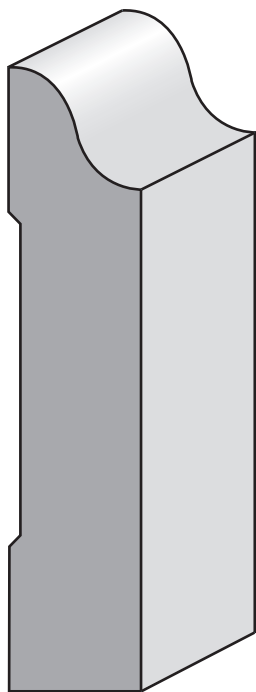

PAC 2101
11/16 X 3-1/4

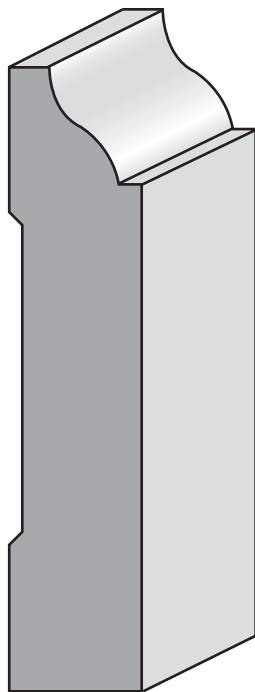

PAC 2102
11/16 X 3- 1/4

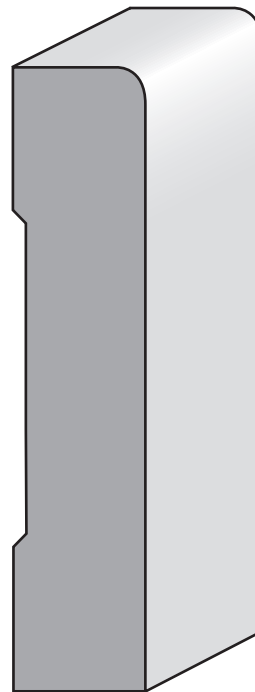

PAC 2104
11/16 X 3-1/4

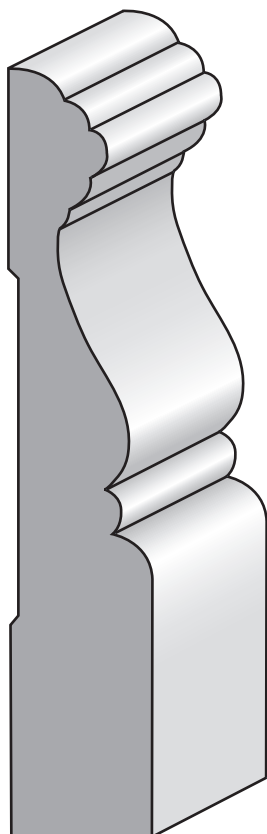

PAC 2112
3/4 X 3-1/2

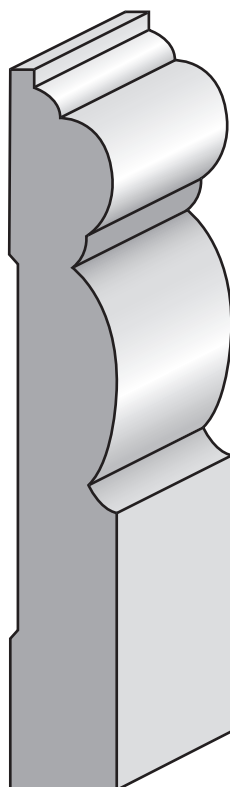

PAC 2114
9/16 X 3-3/4

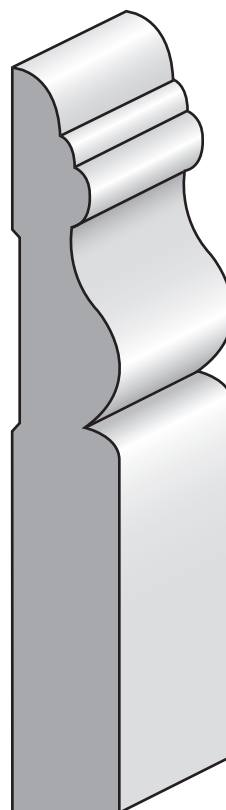

PAC 2115
9/16 X 3-7/8

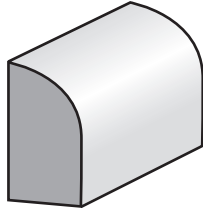

PAC 2133
3/8 X 3/4

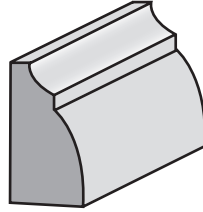

PAC 2134
3/8 X 3/4

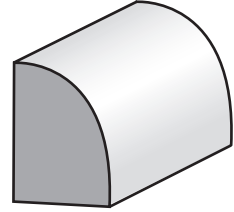

PAC 2135
1/2 X 3/4

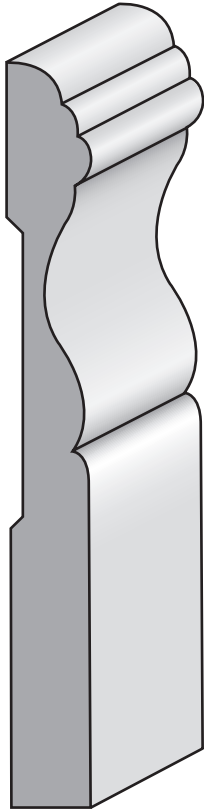

PAC 2116
7/16 X 3-7/8

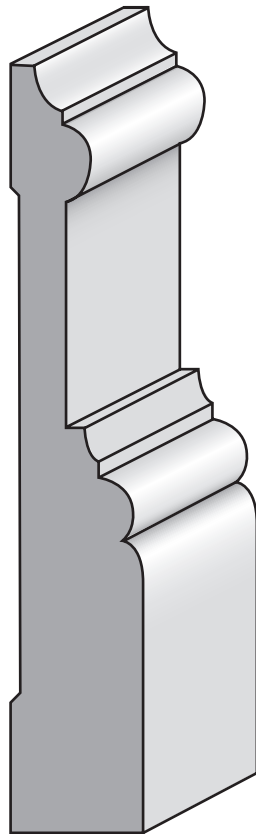

PAC 2119
11/16 X 4

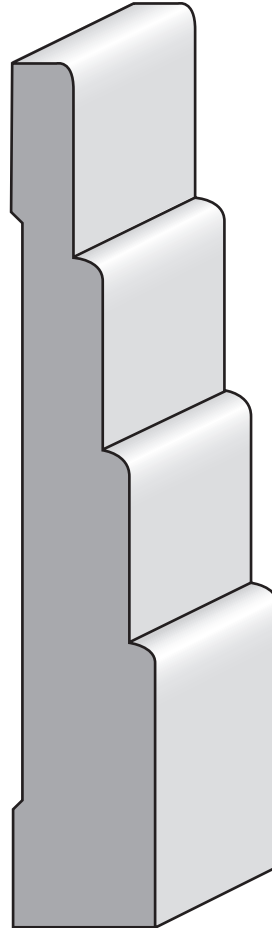

PAC 2122
3/4 X 4-1/2

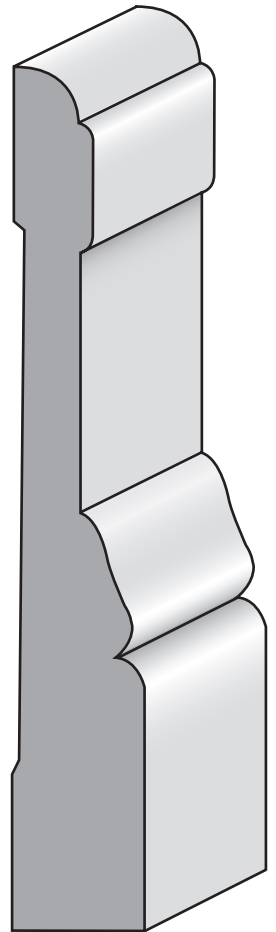

PAC 2123
11/16 X 4-1/2



pacifi**C**HARDWOOD
We Measure Up

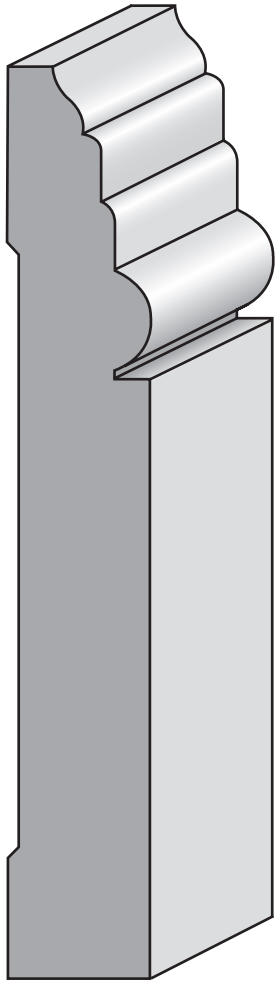

PAC 2125
 3/4 X 4-3/4

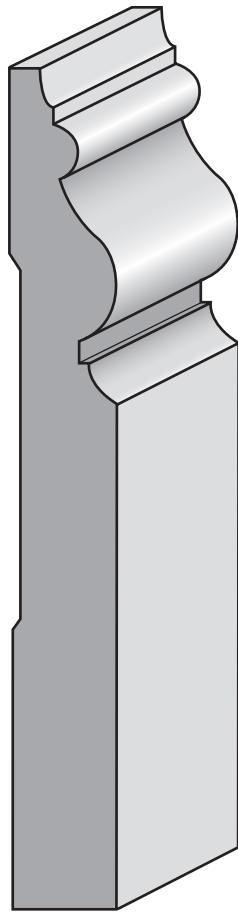

PAC 2121
 9/16 X 4-3/8

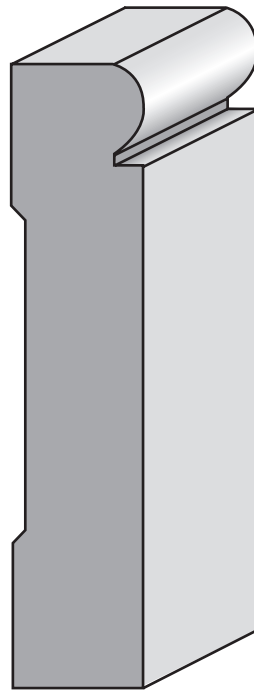

PAC 2105
 11/16 X 3-1/4

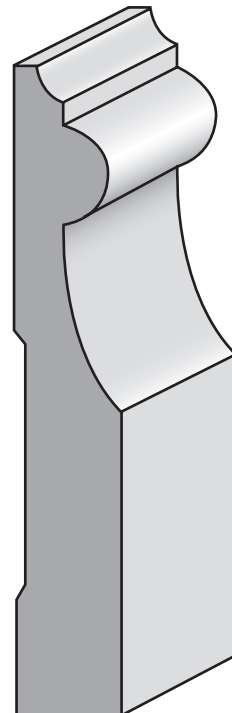

PAC 2106
 9/16 X 3-3/8

www.pacifichardwood.com

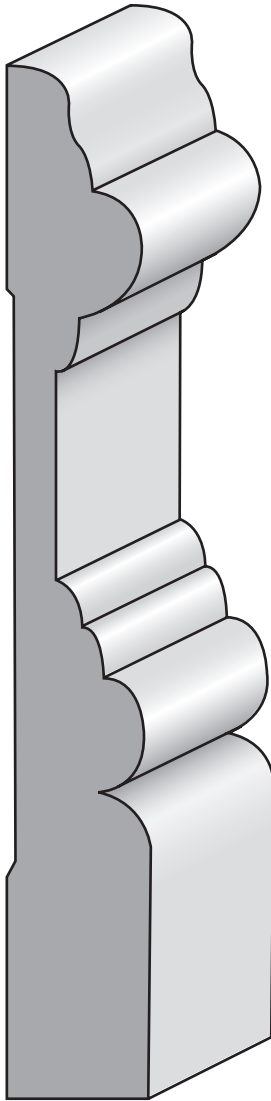

PAC 2129
3/4 X 5-3/8

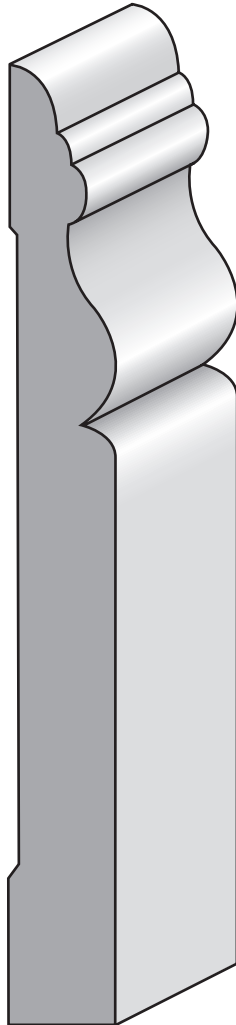

PAC 2126
9/16 X 5

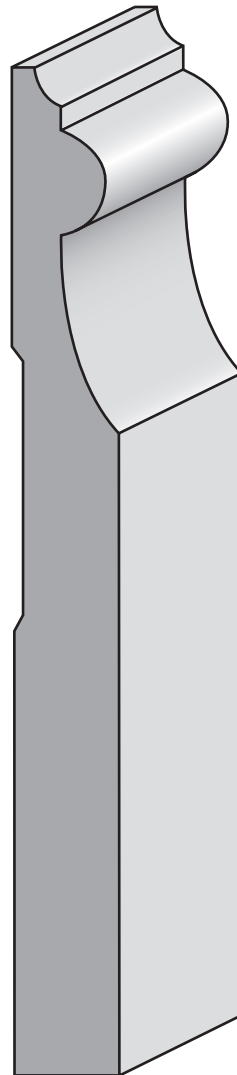

PAC 2127
9/16 X 5-1/4

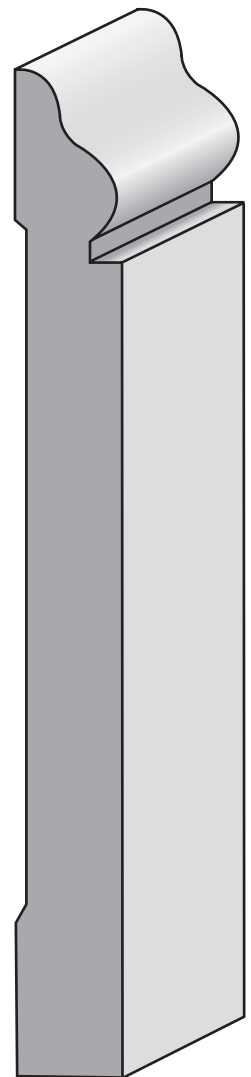

PAC 2128
9/16 X 5-1/4



pacifi**C**HARDWOOD

We Measure Up

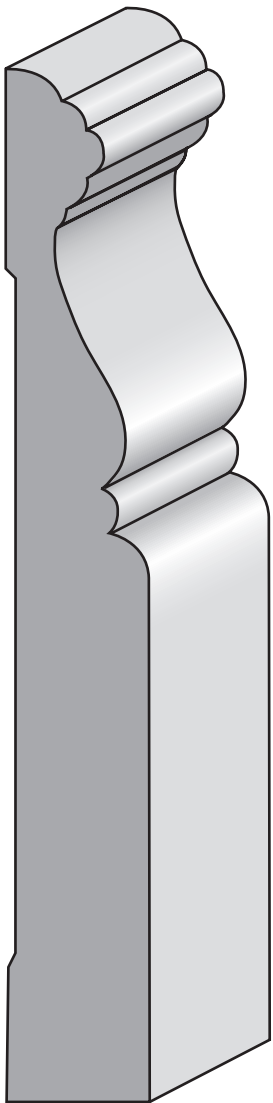

PAC 2130
3/4 X 5-3/8

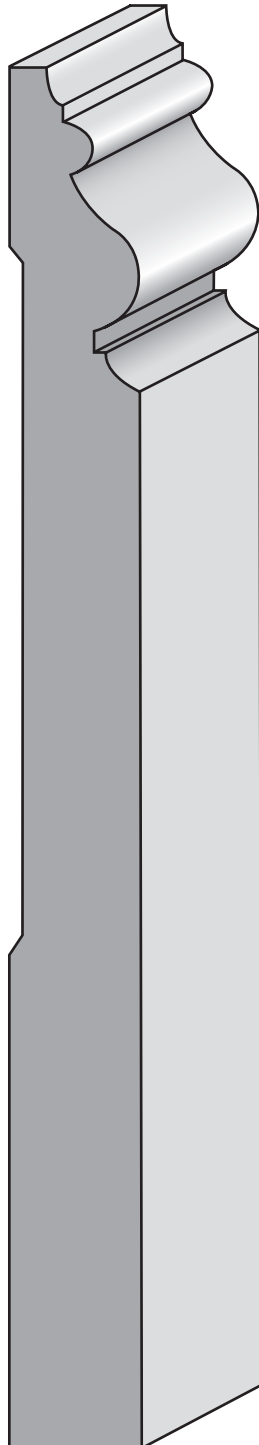

PAC 2131
1 1/16 x 7-3/16

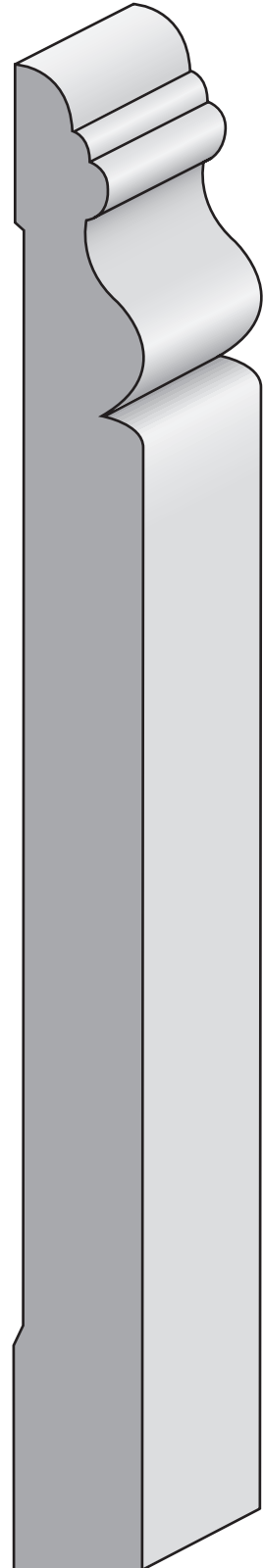

PAC 2132
1 1/16 X 8

PH 714.998.6446

Fx 714.998.6260

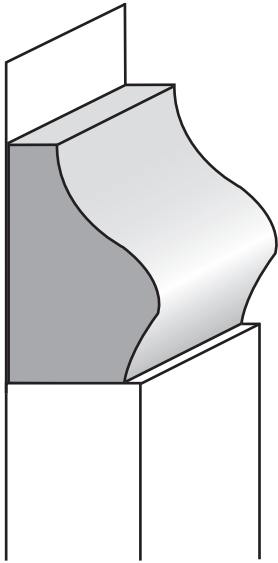

PAC 1103
3/4 X 1

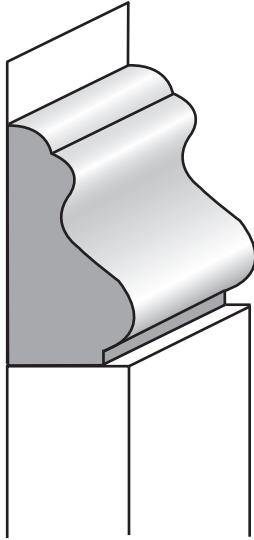

PAC 1107
21/32 X 1-1/4

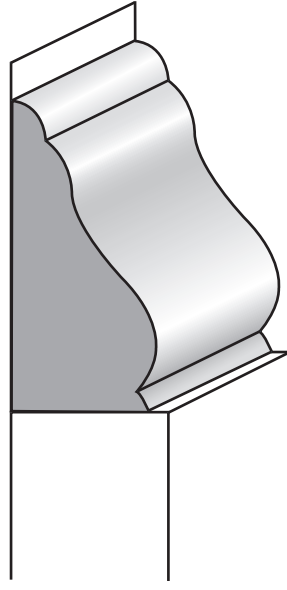

PAC 1104
3/4 X 1-5/8

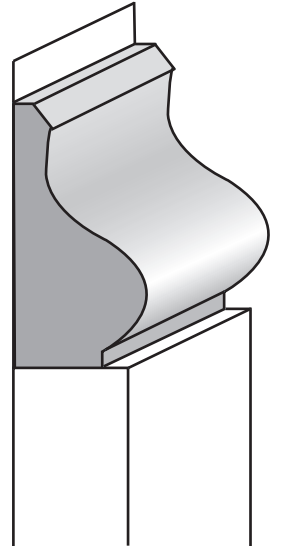

PAC 1106
11/16 X 1-3/8

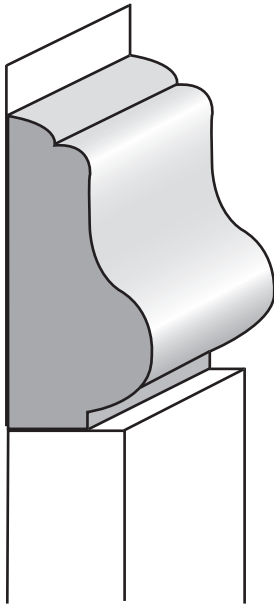

PAC 1102
3/4 X 1-5/8

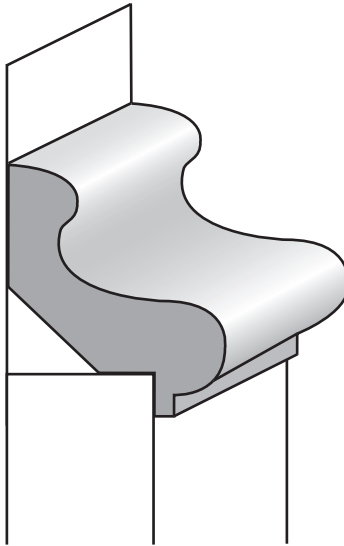

PAC 8103
1-1/8 X 1-5/16

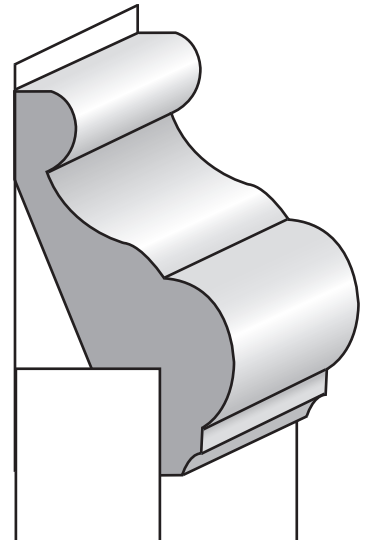

PAC 8105
3/4 X 2



pacifi**CH**ARDWOOD
We Measure Up

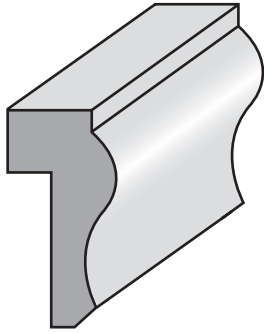

PAC 7100
 9/16 X 1-1/8

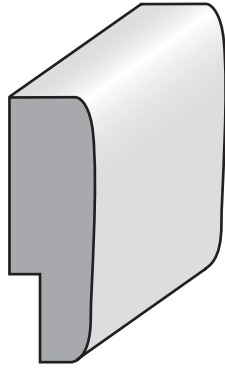

PAC 7101
 7/16 X 1-3/8

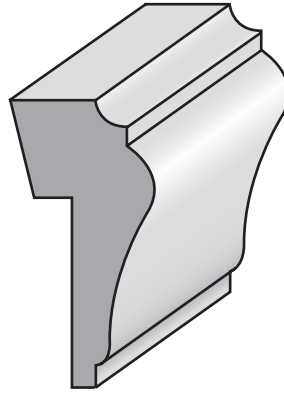

PAC 7102
 3/4 X 1-1/2

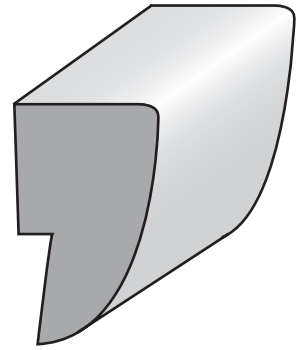

PAC 7103
 3/4 X 1-1/4

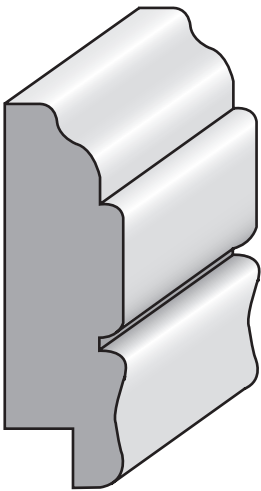

PAC 7104
 5/8 X 2

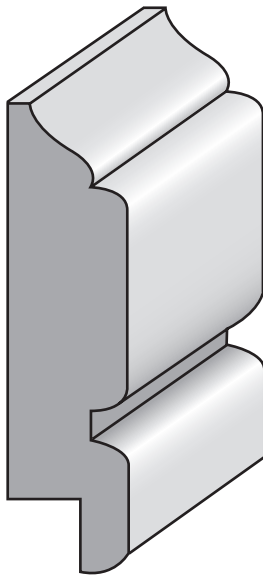

PAC 7106
 5/8 X 2-7/16

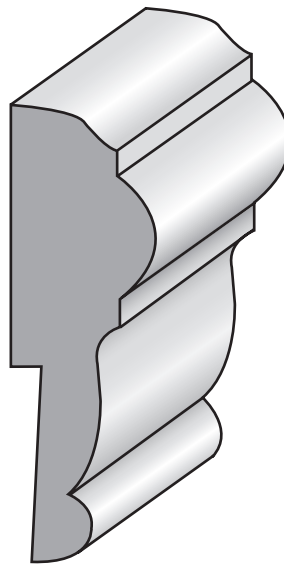

PAC 7105
 3/4 X 2-3/8

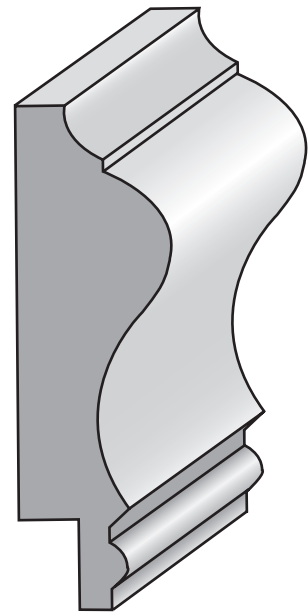

PAC 7107
 13/16 X 2-5/8

www.pacifichardwood.com

PH 714.998.6446

Fx 714.998.6260



pacificHARDWOOD

We Measure Up

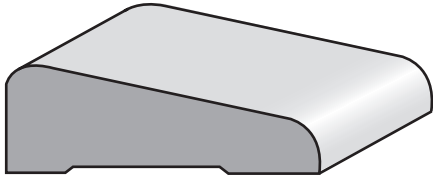

PAC 6127
9/16 X 1-5/8

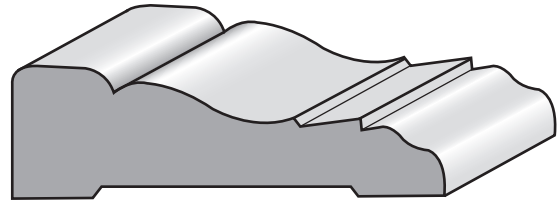

PAC 6118
11/16 X 2-1/4



PAC 6129
9/16 X 1-5/8

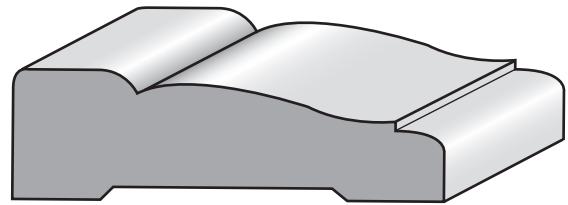

PAC 6114
11/16 X 2-1/4

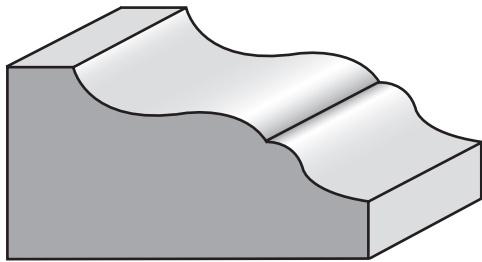

PAC 6112
1 X 1-7/8

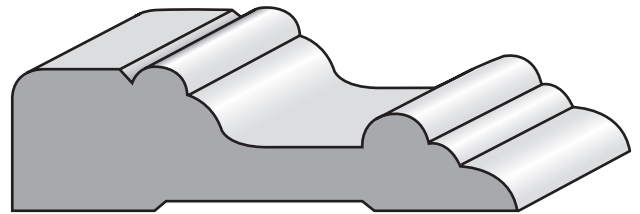

PAC 6101
3/4 X 2-5/8

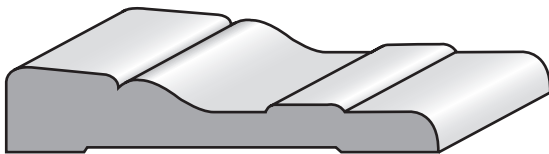

PAC 6132
7/16 X 2-1/4

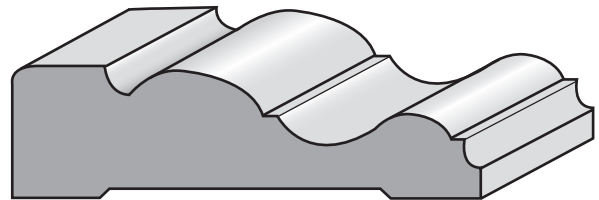

PAC 6115
11/16 X 2-7/16



pacifi**C**HARDWOOD
We Measure Up

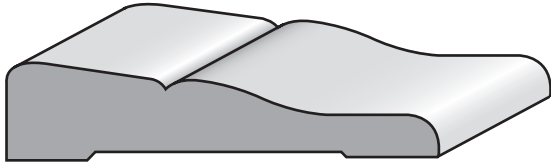

PAC 6131
 1/2 X 2-1/4

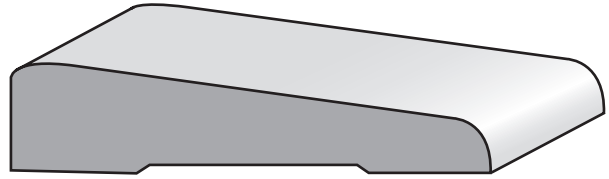

PAC 6128
 9/16 X 2-1/2

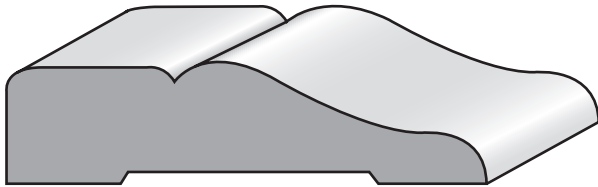

PAC 6102
 5/8 X 2-1/2

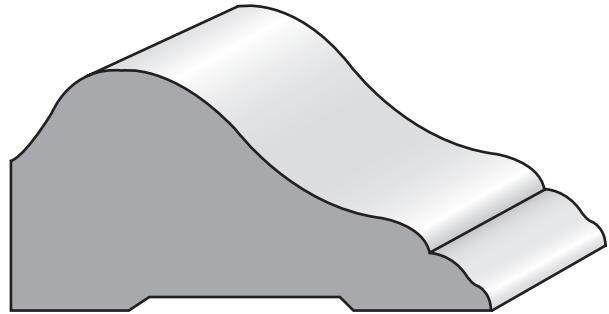

PAC 6107
 1-1/4 X 2-1/2

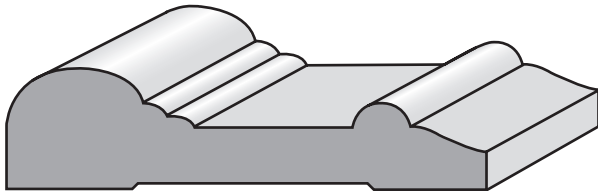

PAC 6136
 5/8 X 2-1/2

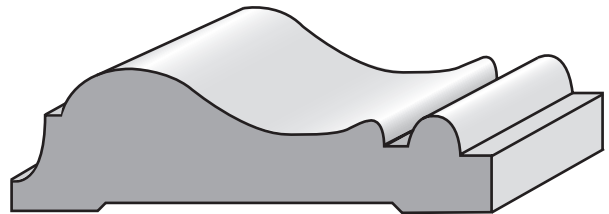

PAC 6134
 3/4 X 2-1/2

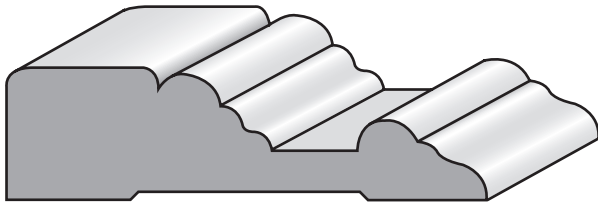

PAC 6137
 11/16 X 2-1/2

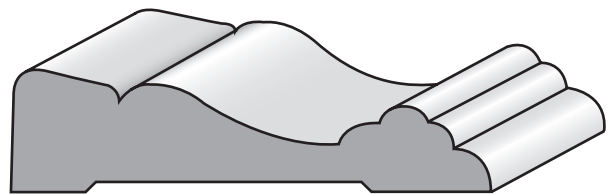

PAC 6135
 5/8 X 2-1/2

www.pacifichardwood.com

PH 714.998.6446

Fx 714.998.6260



pacifi**C**HARDWOOD

We Measure Up

Casing

www.pacifichardwood.com

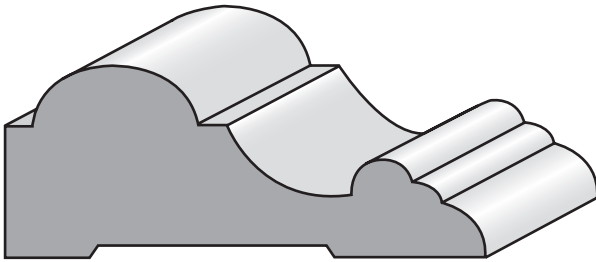

PAC 6105
1 X 2-1/2

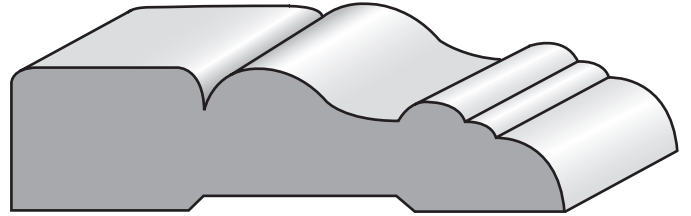

PAC 6110
3/4 X 2-7/8

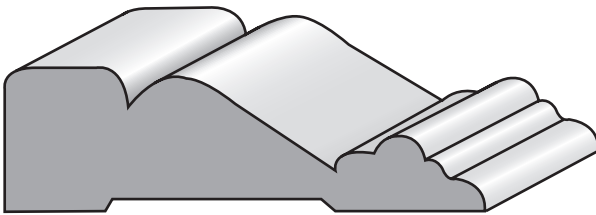

PAC 6120
3/4 X 2-1/2

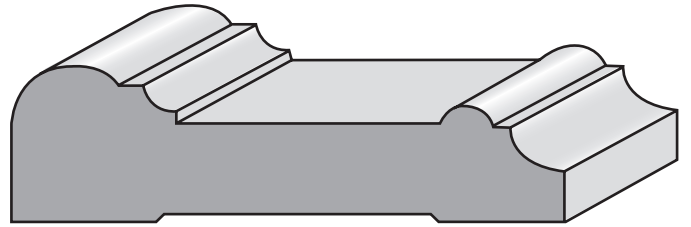

PAC 6138
13/16 X 2-7/8

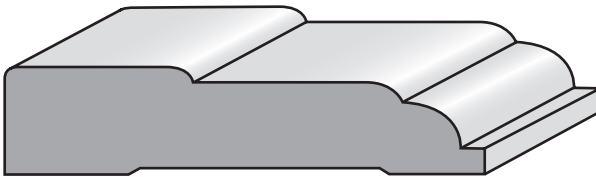

PAC 6133
9/16 X 2-1/2

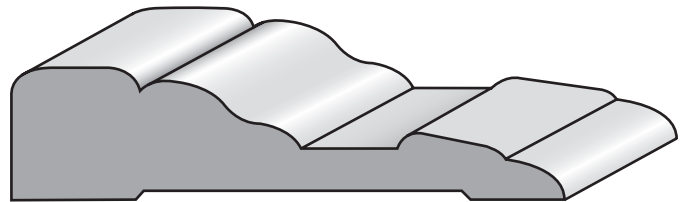

PAC 6119
11/16 X 2-7/8

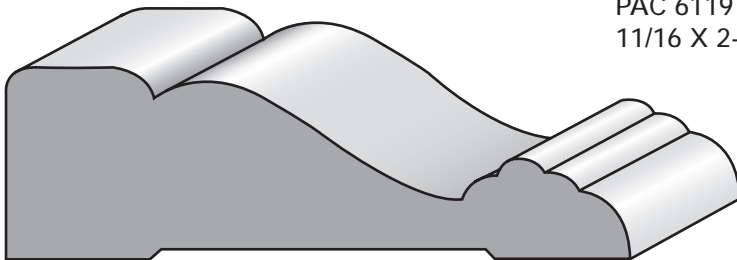

PAC 6117
1 X 3-1/4



pacificHARDWOOD
We Measure Up

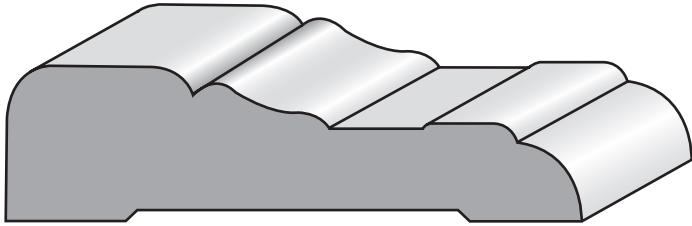

PAC 6140
 13/16 X 3

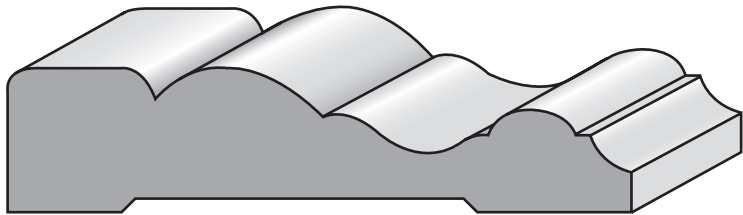

PAC 6122
 3/4 X 3-1/4

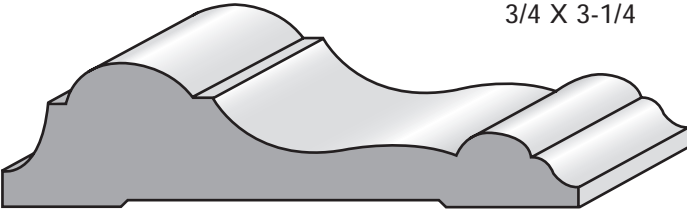

PAC 6141
 3/4 X 3

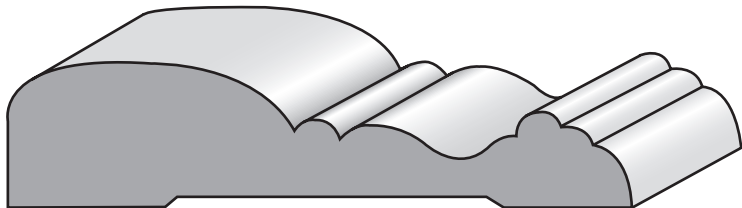

PAC 6116
 3/4 X 3-1/4

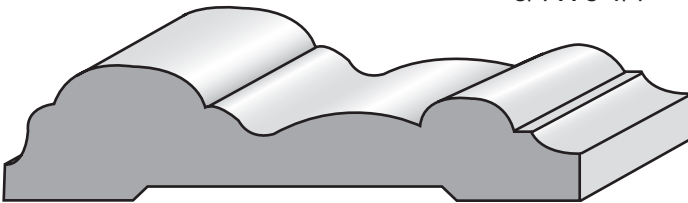

PAC 6108
 11/16 X 3

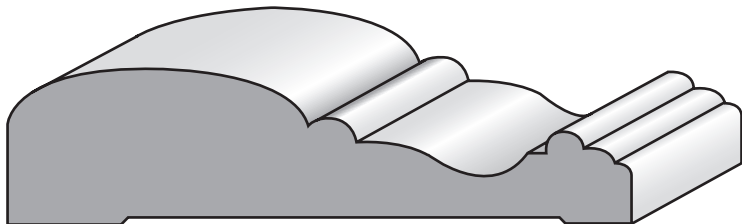

PAC 6142
 25/32 X 3-1/4

www.pacifichardwood.com

PH 714.998.6446

Fx 714.998.6260

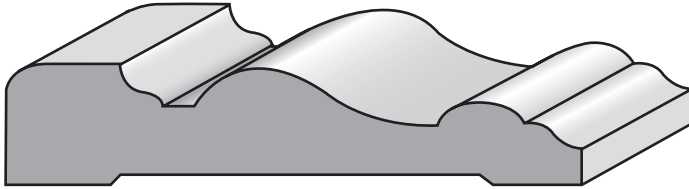

PAC 6103
5/8 X 3

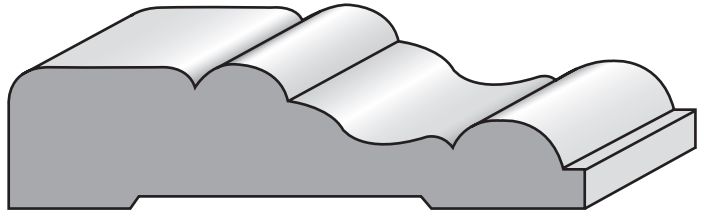

PAC 6104
3/4 X 3

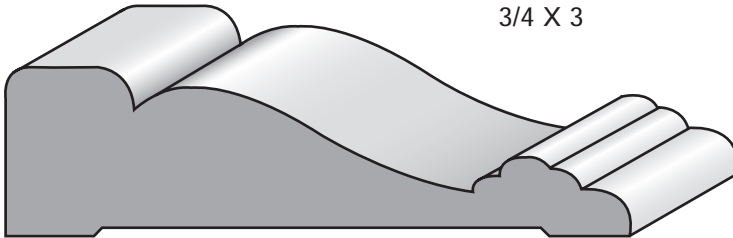

PAC 6143
7/8 X 3-1/4

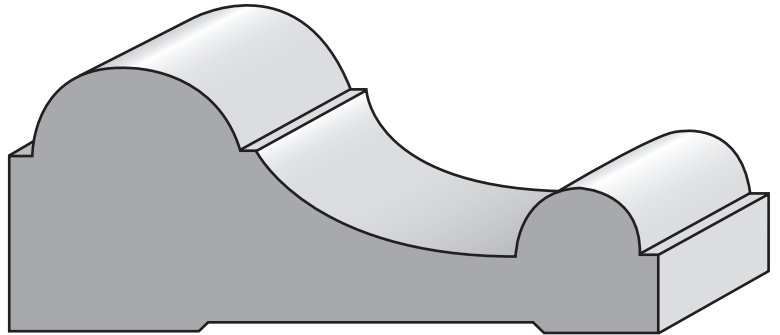

PAC 6144
1-3/8 X 3-3/8

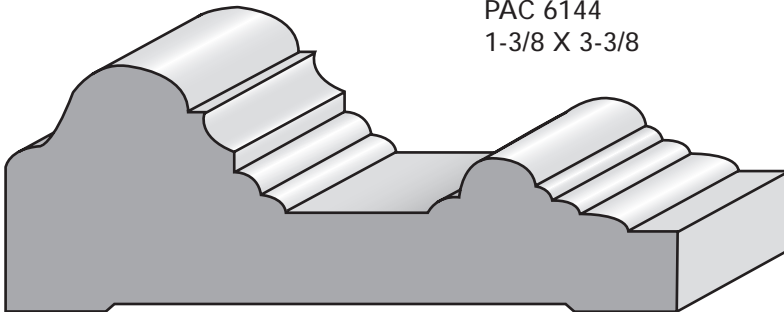

PAC 6145
1-3/8 X 3-1/2



pacifi**CH**ARDWOOD
We Measure Up

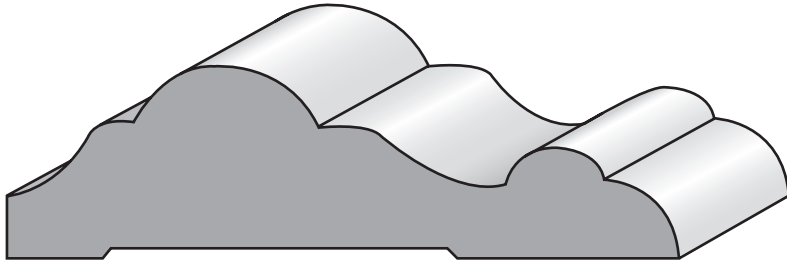

PAC 6106
 1 X 3-1/2

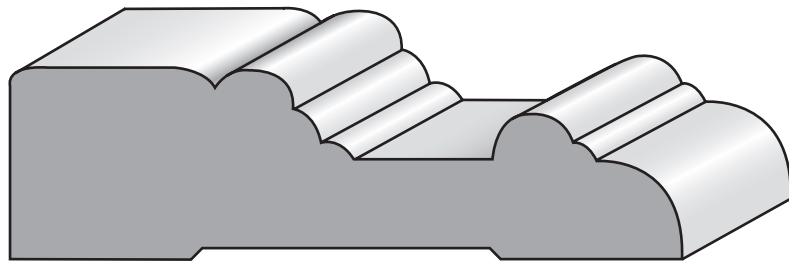

PAC 6121
 1 X 3-1/2

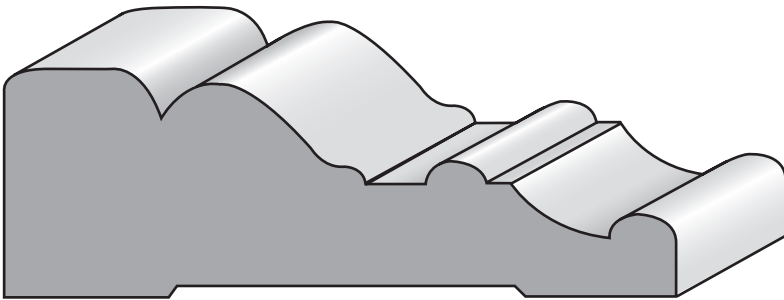

PAC 6124
 1-3/16 X 3-1/2

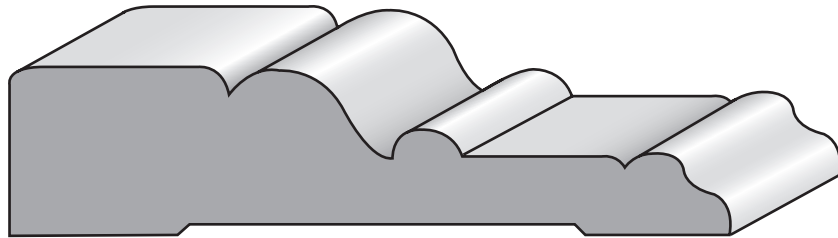

PAC 6123
 7/8 X 3-3/4

www.pacifichardwood.com

PH 714.998.6446

Fx 714.998.6260

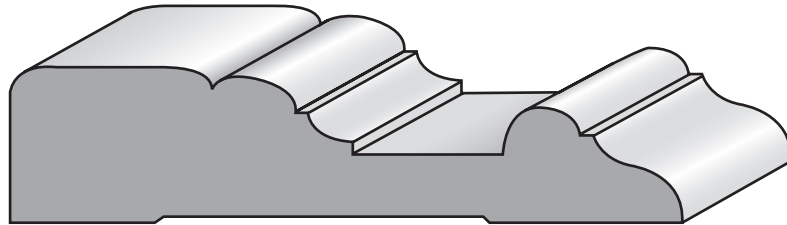

PAC 6166
13/16 X 3-1/2

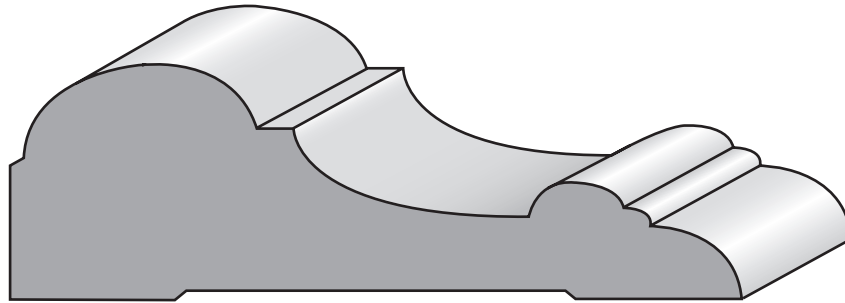

PAC 6113
1-3/16 X 3-13/16

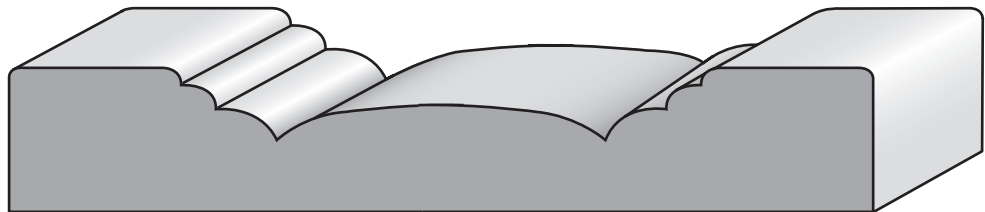

PAC 6126
3/4 X 4-1/2



pacifi**HARDWOOD**
We Measure Up

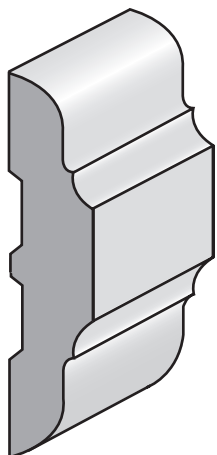

PAC 6519
 7/16 X 2

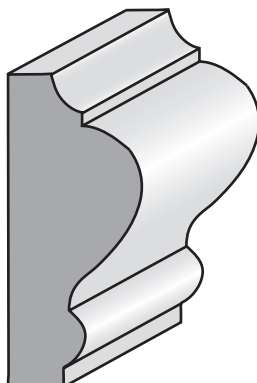

PAC 6520
 11/16 X 1-5/8

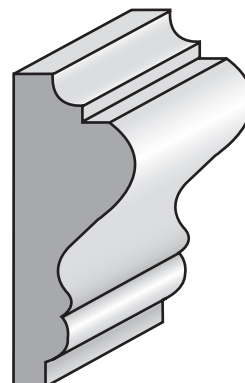

PAC 6521
 5/8 X 1-5/8

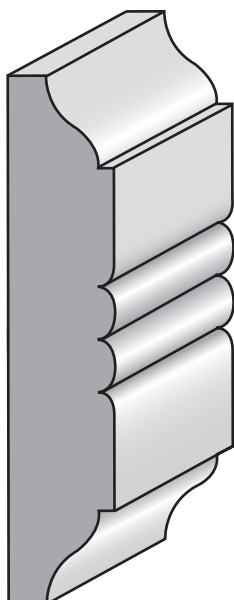

PAC 6512
 9/16 X 2-3/4

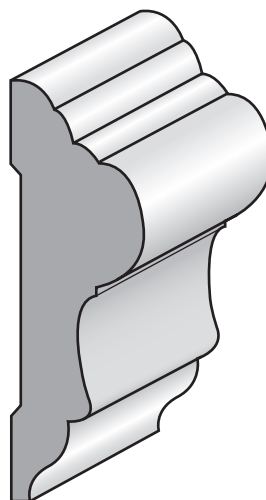

PAC 6518
 11/16 X 2-3/16

www.pacifichardwood.com

PH 714.998.6446

Fx 714.998.6260

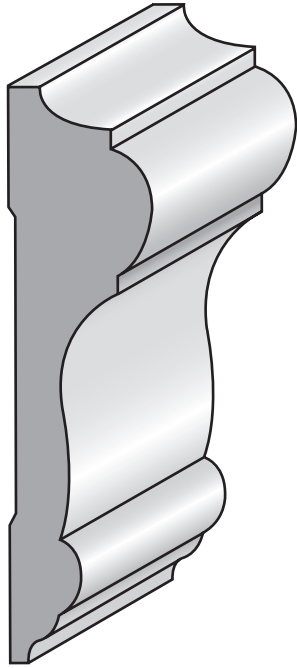

PAC 6513
3/4 X 3

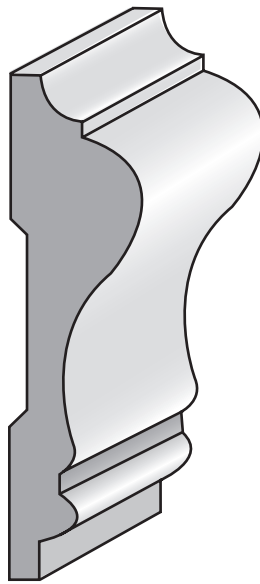

PAC 6514
5/8 X 2-5/8

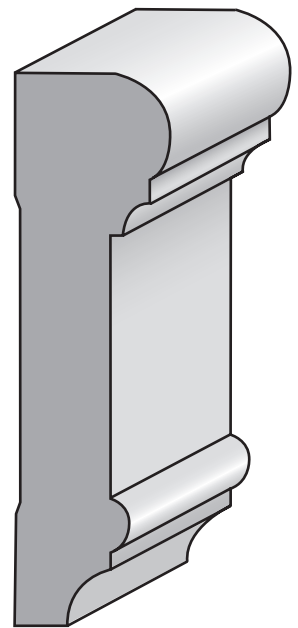

PAC 6511
13/16 X 2-7/8



pacifi**C**HARDWOOD
We Measure Up

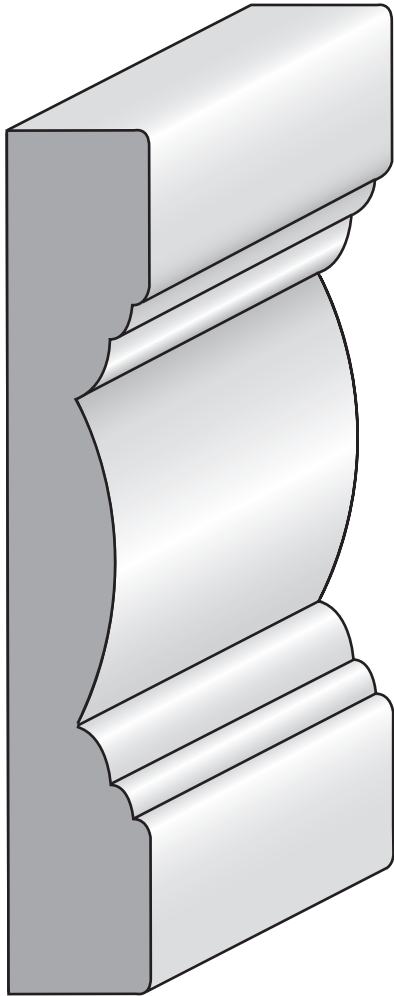

PAC 6510
3/4 X 4-1/2

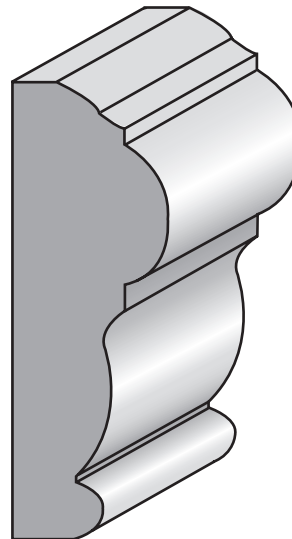

PAC 6517
13/16 X 2-3/8

PH 714.998.6446

Fx 714.998.6260



Cove

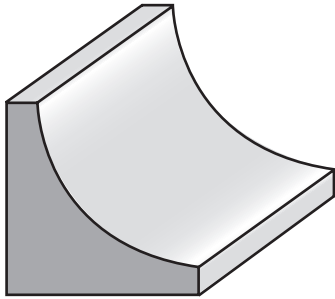

PAC 7512
1 X 1

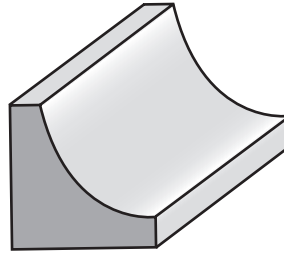

PAC 7513
3/4 X 3/4

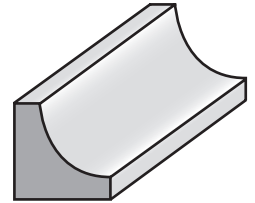

PAC 7514
1/2 X 1/2

Quarter Round

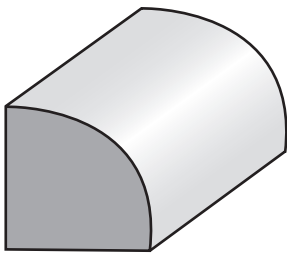

PAC 7518
3/4 X 3/4

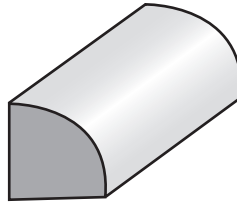

PAC 7519
1/2 X 1/2

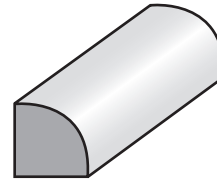

PAC 7520
3/8 X 3/8

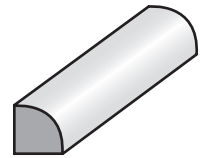

PAC 7521
1/4 X 1/4

Outside Corner

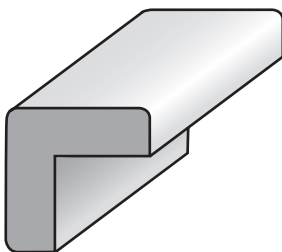

PAC 9510
3/4 X 3/4

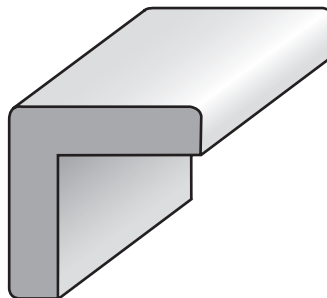

PAC 9511
1 X 1

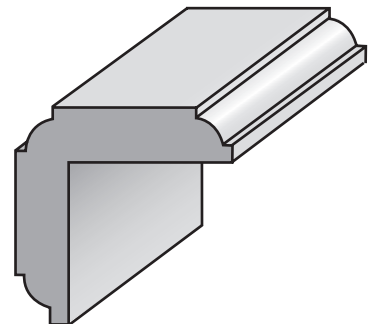

PAC 9512
1-1/8 x 1-1/8



pacifi**C**HARDWOOD
We Measure Up

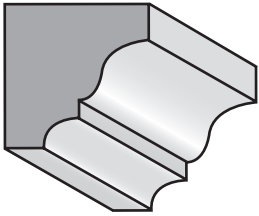

PAC 3113
 3/4 X 3/4

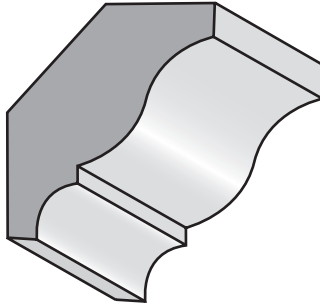

PAC 3112
 9/16 X 1-5/8

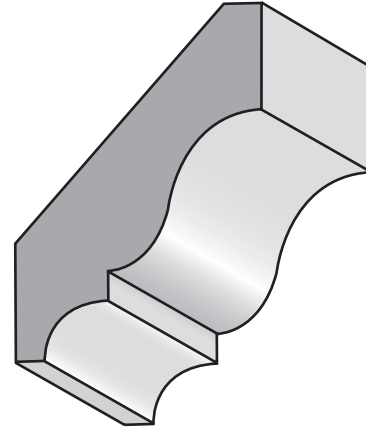

PAC 3111
 9/16 X 2-1/4

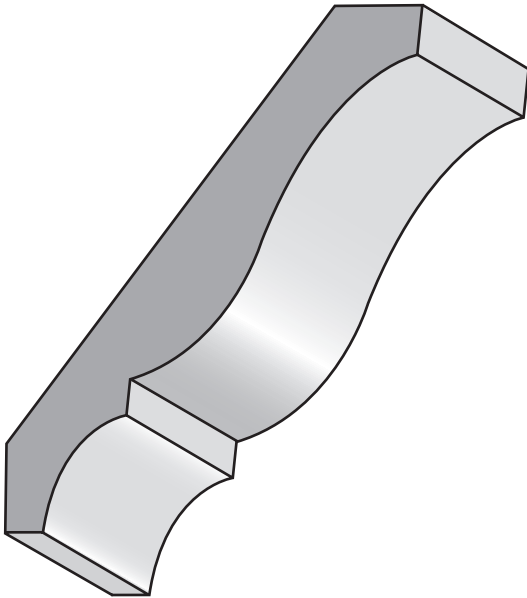

PAC 3110
 1/2 X 3-1/2

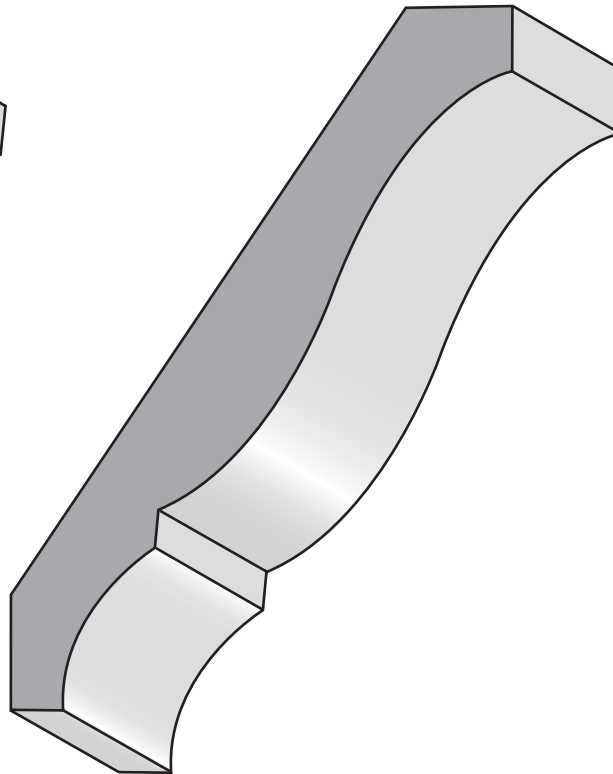

PAC 3109
 5/8 X 4-1/2

www.pacifichardwood.com

PH 714.998.6446

Fx 714.998.6260



pacificHARDWOOD
We Measure Up

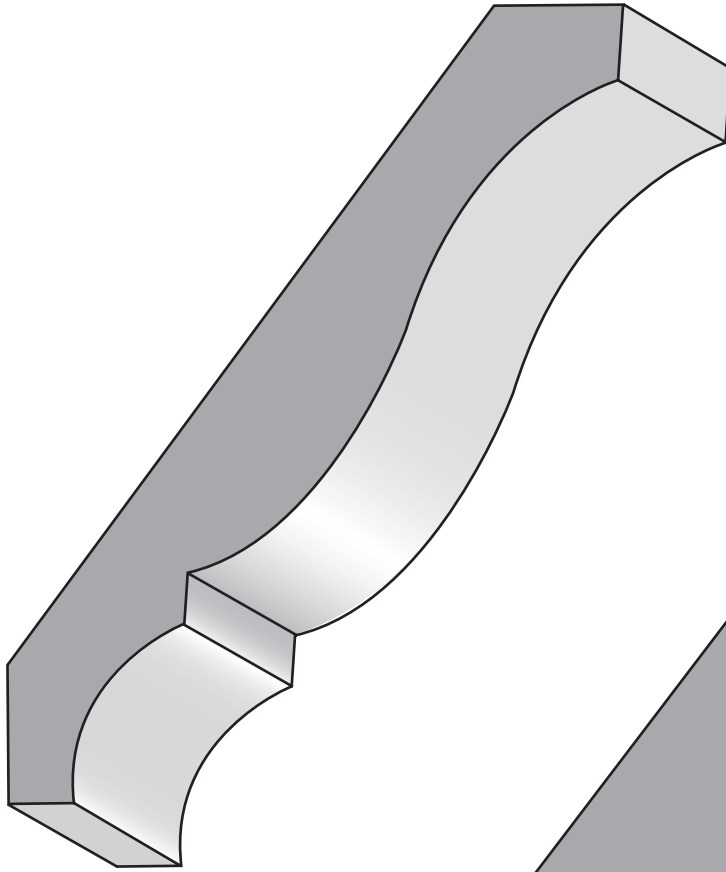

PAC 3108
3/4 X 5-1/4

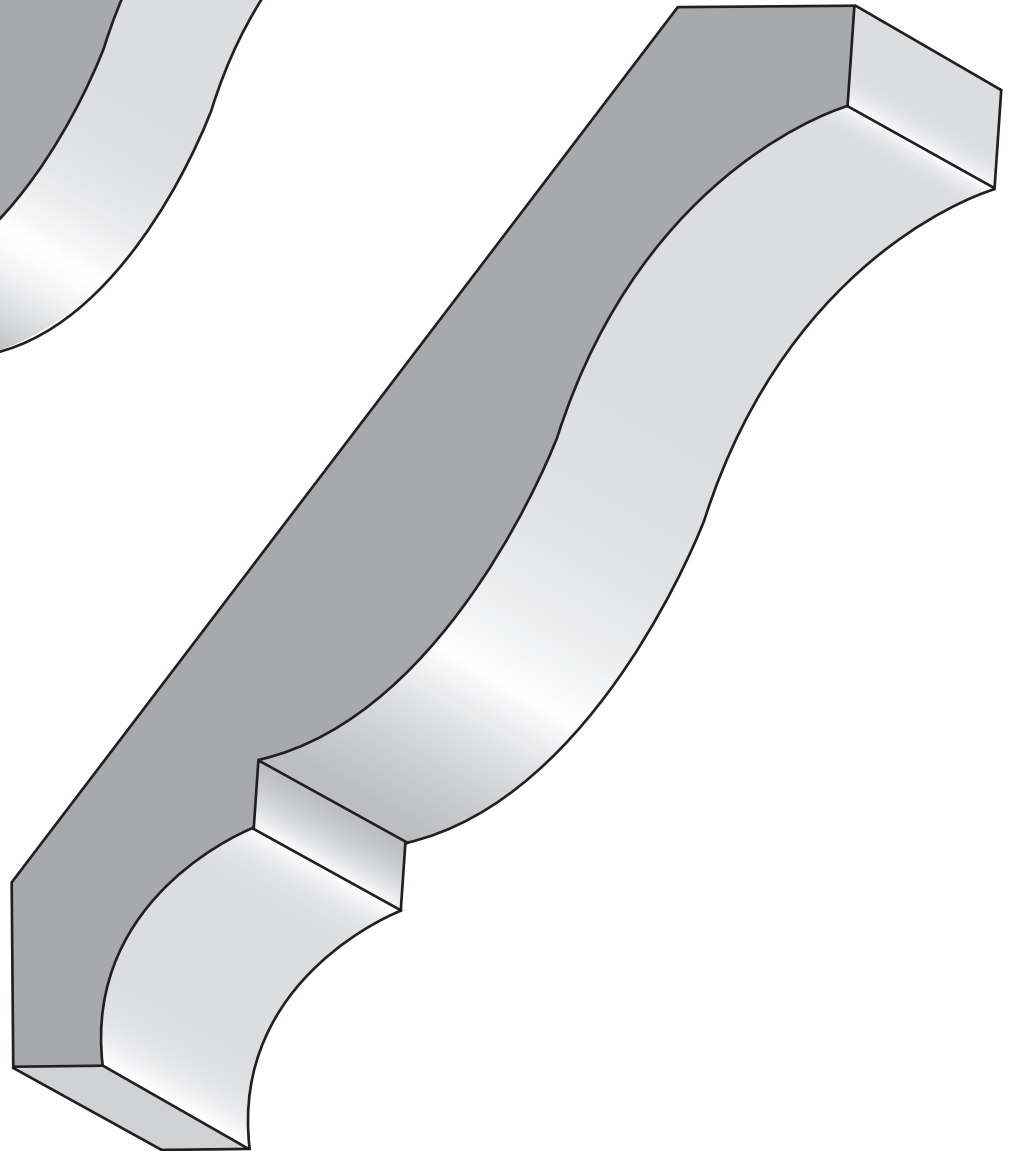

PAC 3107
7/8 X 7-1/4



pacifi**CH**ARDWOOD
We Measure Up

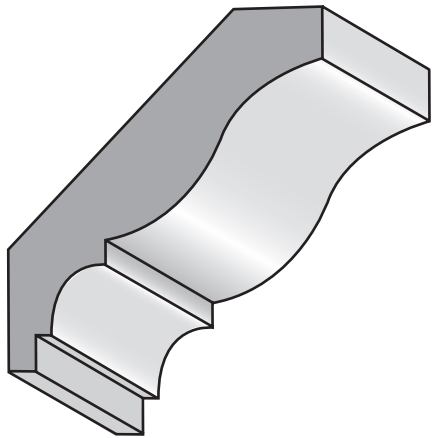

PAC 3103
 9/16 X 2-1/2

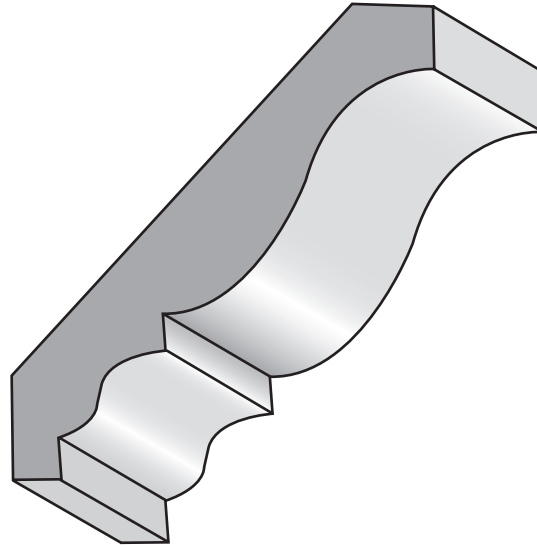

PAC 3102
 9/16 X 3-1/4

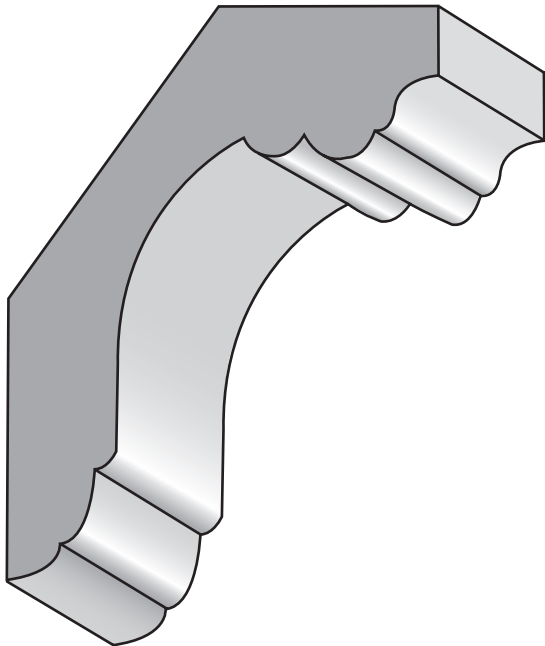

PAC 3101
 1-1/8 X 3-3/4

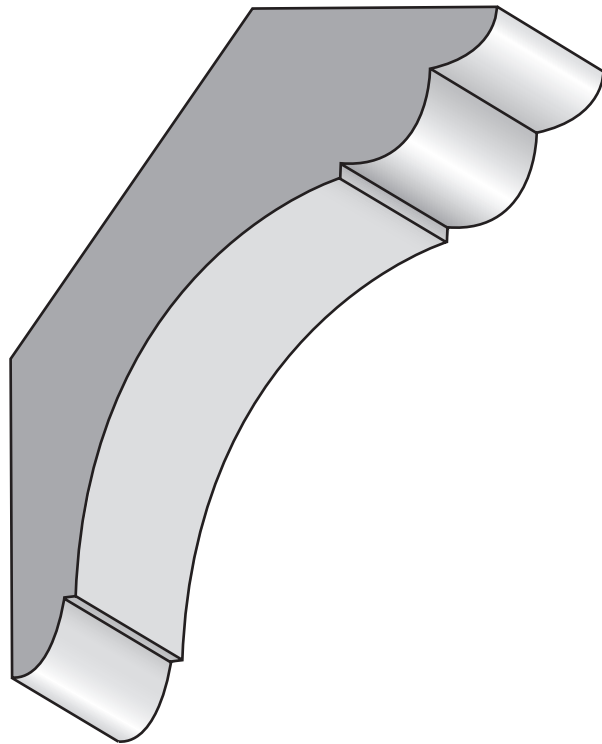

PAC 3100
 1-1/16 X 4-5/16

PH 714.998.6446

Fx 714.998.6260



pacificHARDWOOD

We Measure Up

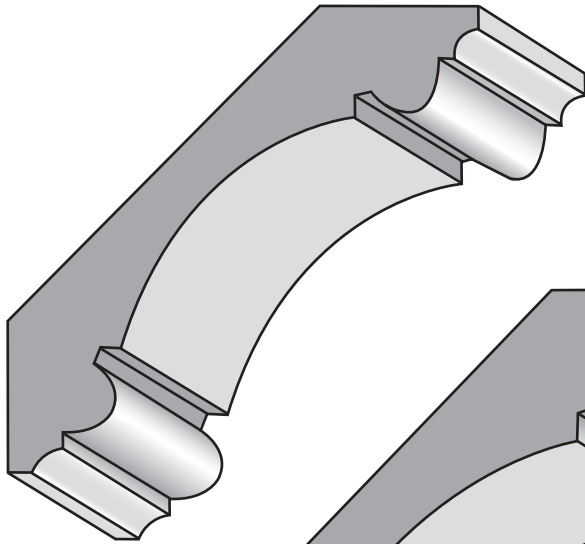

PAC 3106
3/4 X 3-7/16

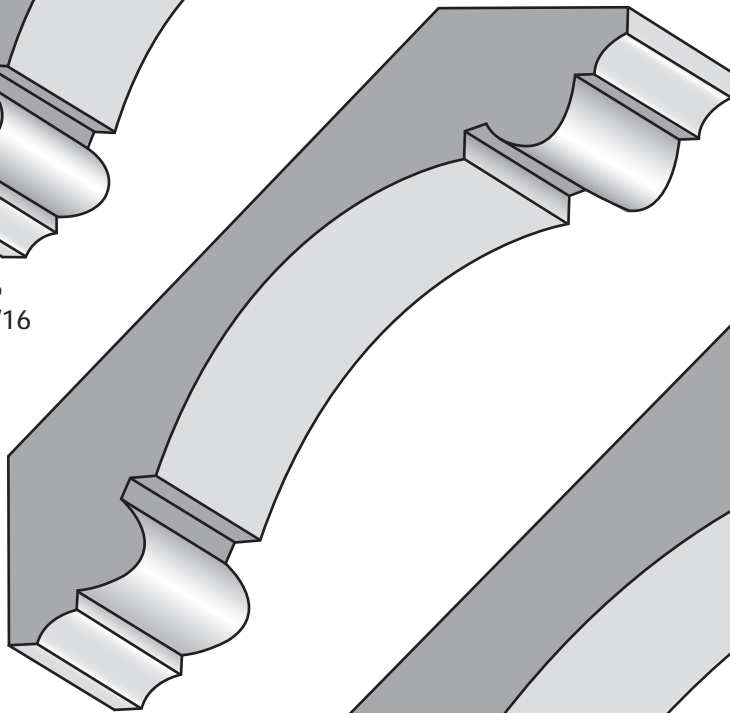

PAC 3105
7/8 X 4-5/8

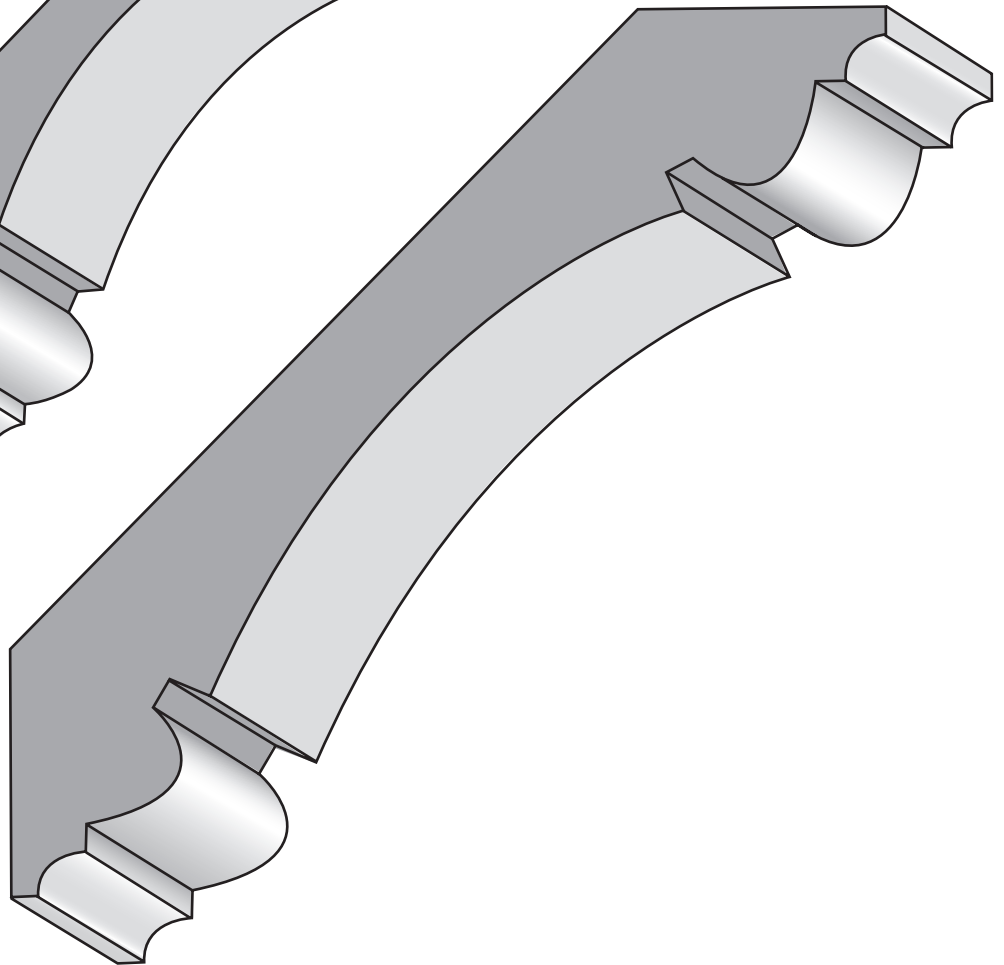

PAC 3104
1-1/8 X 6-1/2



pacifi**C**HARDWOOD

We Measure Up

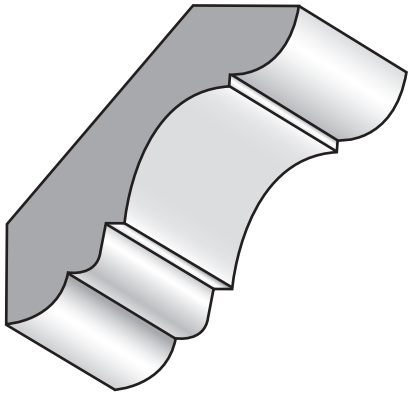

PAC 3122
1/2 X 2-1/4

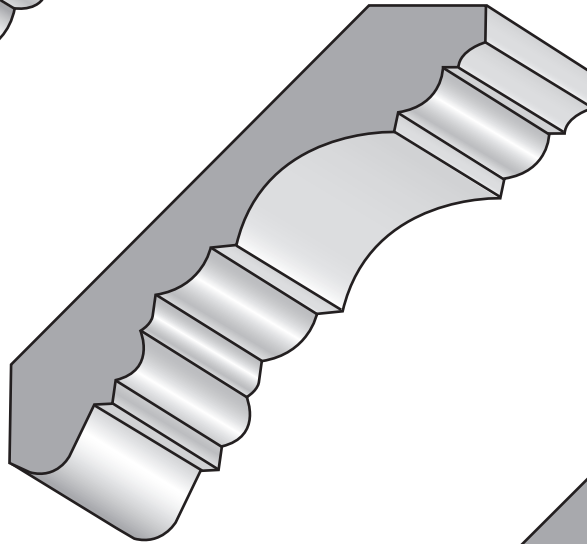

PAC 3120
9/16 X 3-7/16

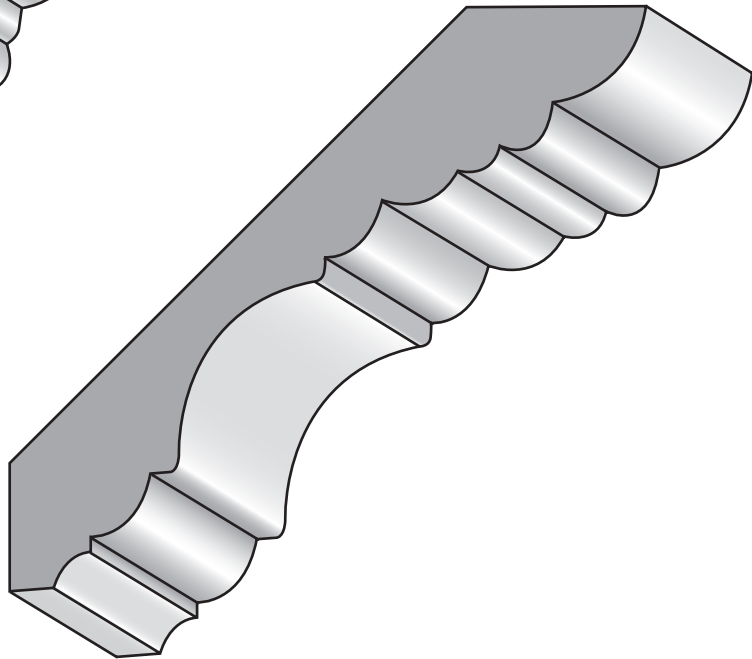

PAC 3119
3/4 X 4-1/2

PH 714.998.6446

Fx 714.998.6260

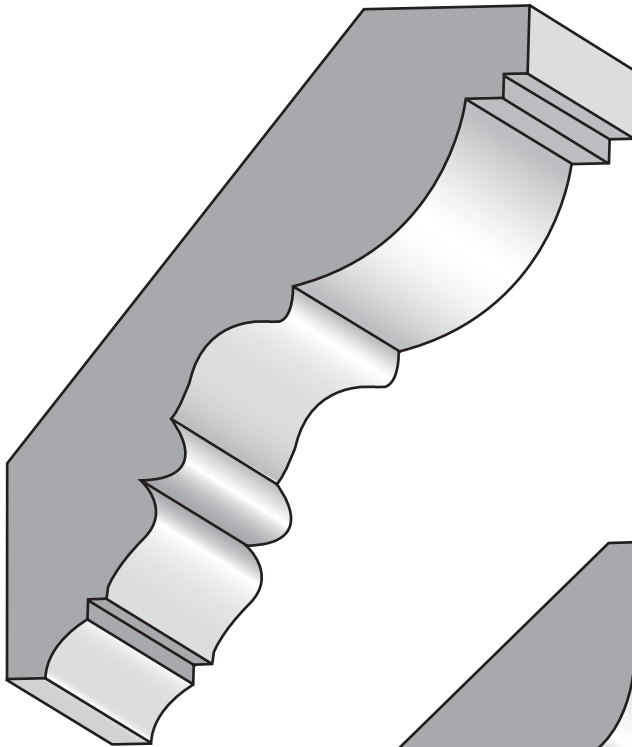

PAC 3125
7/8 X 4-7/16

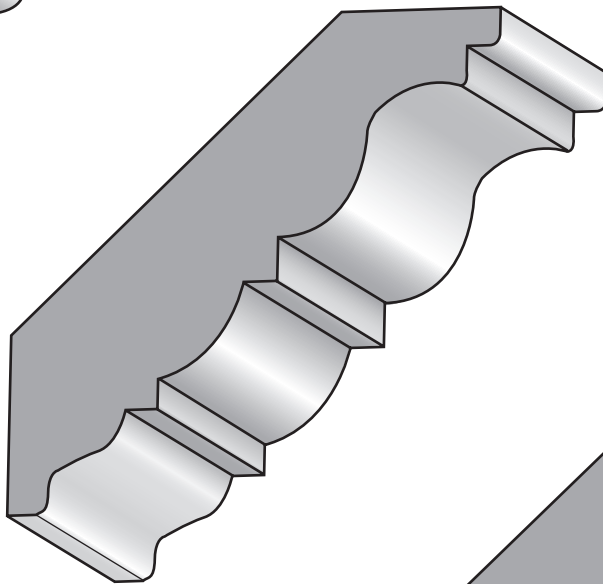

PAC 3126
13/16 X 3-11/16

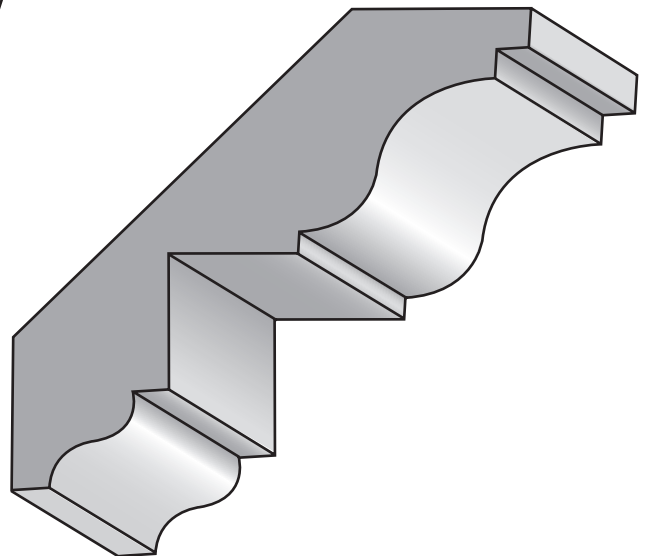

PAC 3127
3/4 X 3-11/16

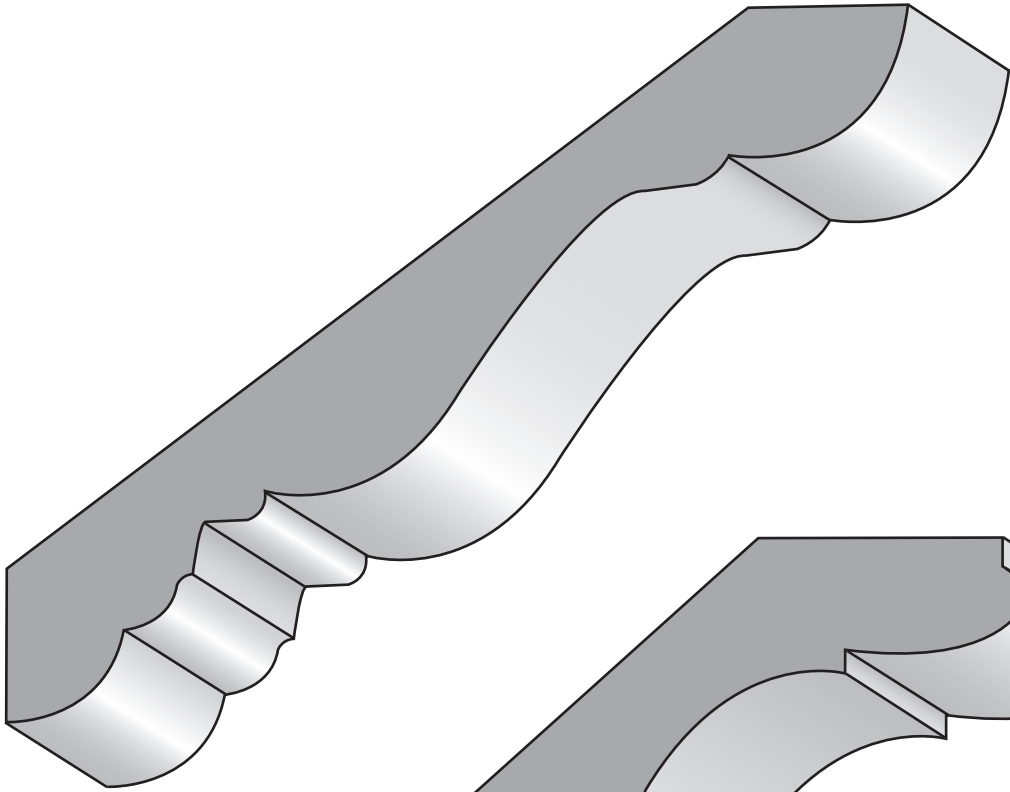

PAC 3117
13/16 X 6

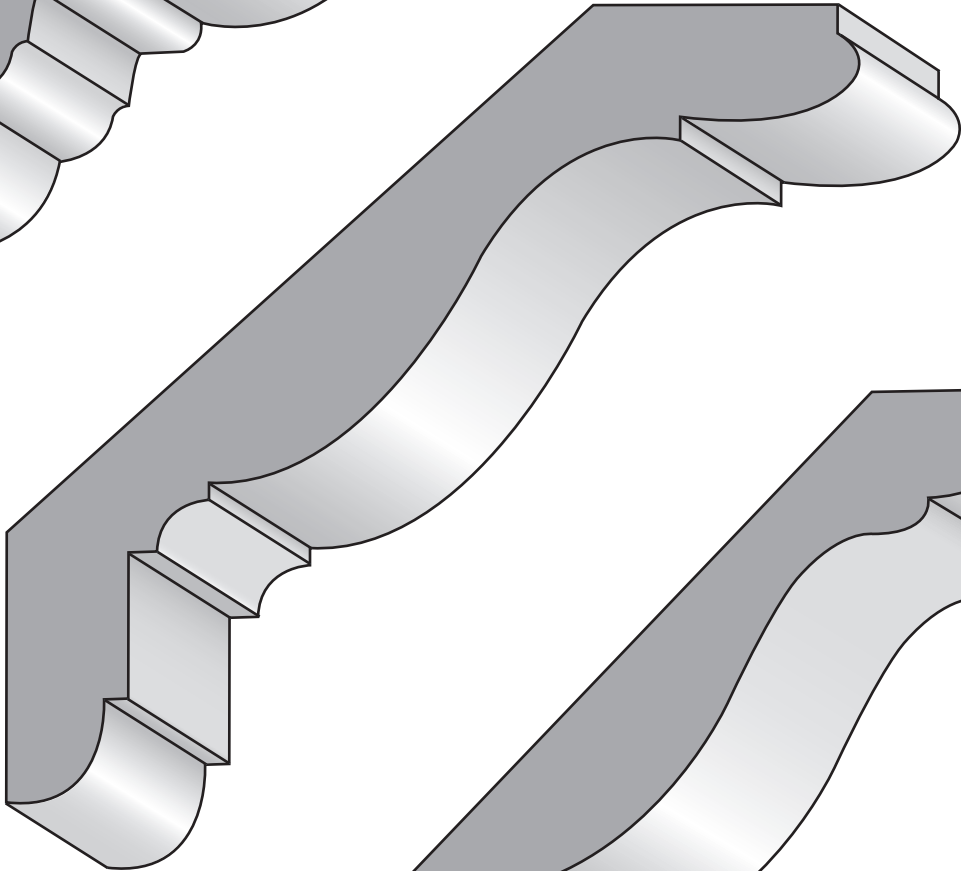

PAC 3116
1-1/4 X 6

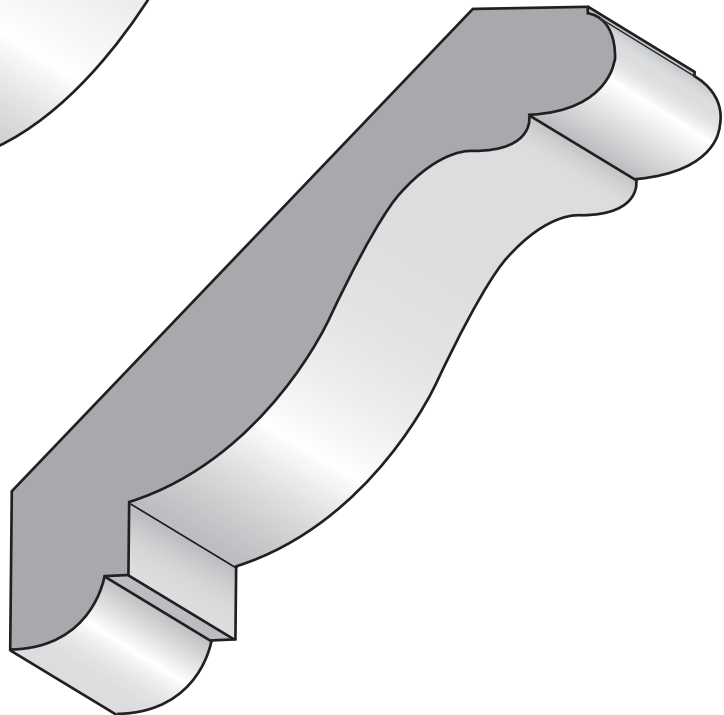

PAC 3118
3/4 X 4-1/2

PH 714.998.6446

Fx 714.998.6260

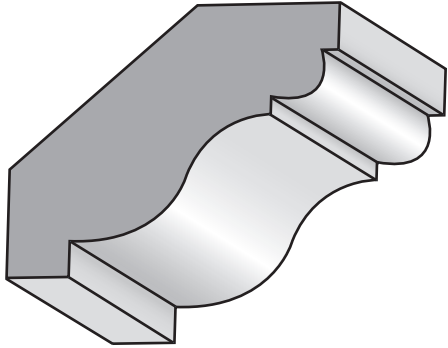

PAC 3115
3/4 X 2-1/4

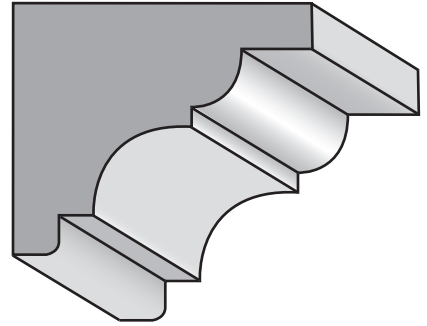

PAC 3128
1-5/16 X 1-9/16

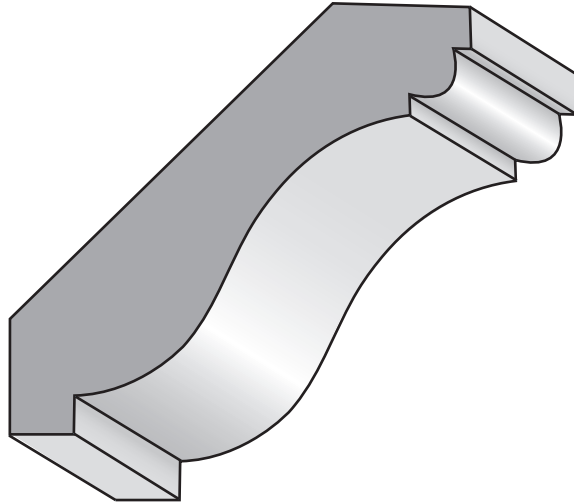

PAC 3114
3/4 X 3-1/4

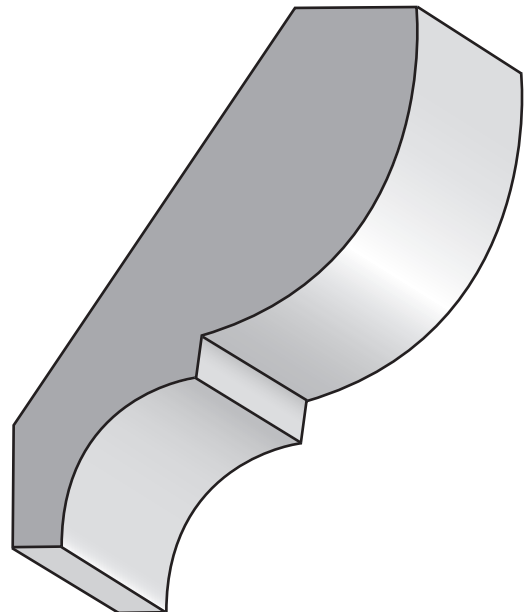

PAC 3129
7/8 X 3-1/2



pacifi**C**HARDWOOD
We Measure Up

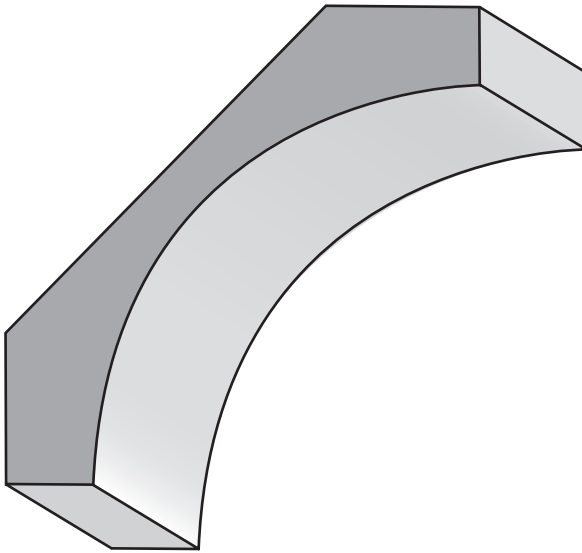

PAC 3124
7/8 X 3-1/2

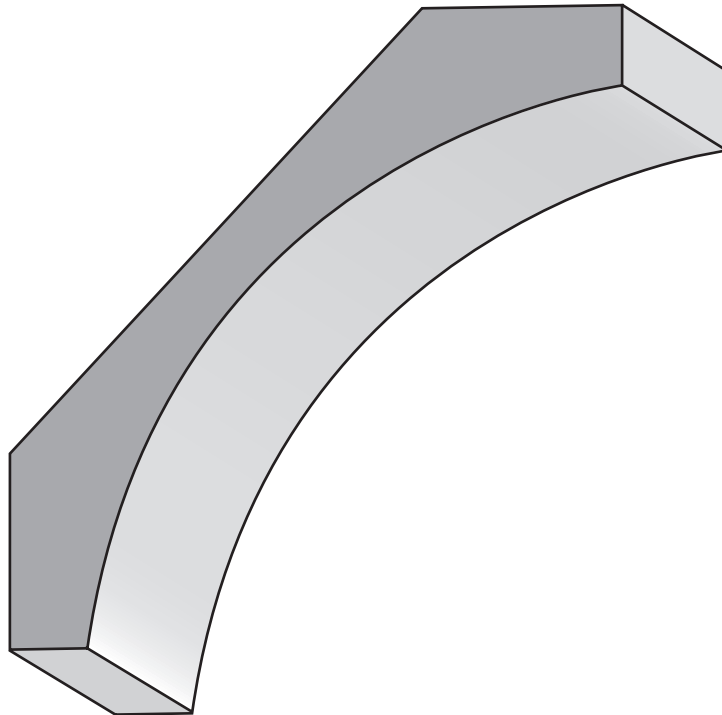

PAC 3123
1 X 4-5/8

PH 714.998.6446

Fx 714.998.6260

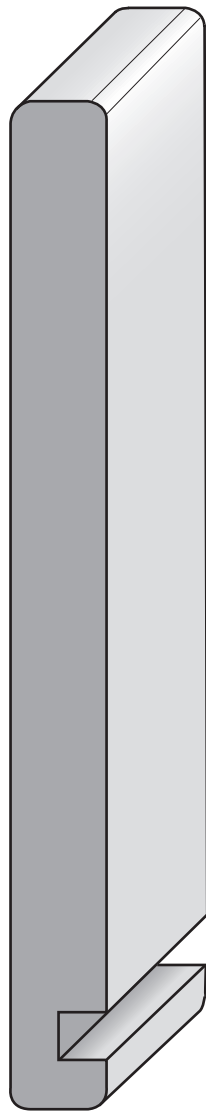

PAC 3130
1/2 X 5-1/4

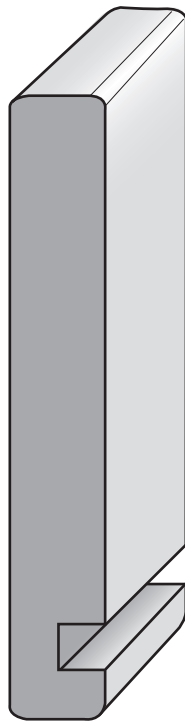

PAC 3131
1/2 X 3-1/4



PAC 3132
1/2 X 2-1/4



pacifi**CH**ARDWOOD

We Measure Up



- Square Edge Flooring
- Flooring available to 12" widths
- Flooring shown at 80% normal size

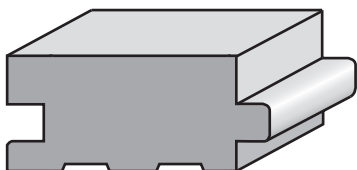

PAC 3535
3/4 X 1-1/2



PAC 3522
3/8 X 1-3/8

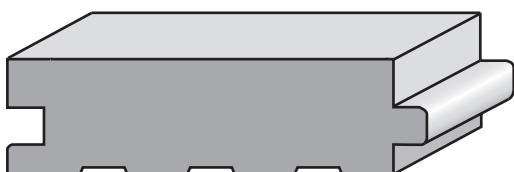

PAC 3516
3/4 X 2-1/2



PAC 3523
1/2 X 1-1/2



PAC 3515
3/4 X 3-1/2



PAC 3524
1/2 X 2



PAC 3512
3/4 X 5-1/4



PAC 3511
3/4 X 7-1/4

www.pacifichardwood.com

PH 714.998.6446

Fx 714.998.6260



- V-Groove Flooring
- Flooring available to 12" widths
- Flooring shown at 80% normal size

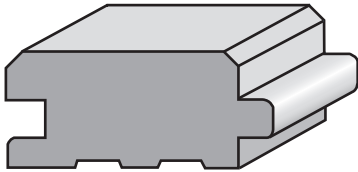

PAC 3545
3/4 X 1-1/2



PAC 3546
3/4 X 2-1/2



PAC 3547
3/4 X 3-1/2



PAC 3548
3/4 X 5-1/4



PAC 3549
3/4 X 7-1/4

And:

Pacific Hardwood now distributes "FloorLayers"* brand engineered wood flooring, the perfect combination of a thick sawn solid face and a high quality laminated hardwood substrate. For more information on this product visit www.floorlayers.com.

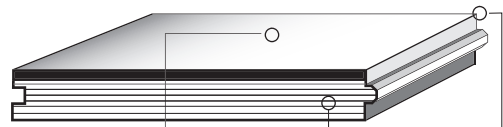

- Plain Sawn 3/16" Wear Layer
- Micro-laminate substrate
- Overall 5/8" Thickness
- Random Lengths to 90"
- Glue Down or Nail Down
- Square or Bevel Edge
- Numerous Custom Options



pacifi**CHARDWOOD**
We Measure Up

Fluting
 Beading

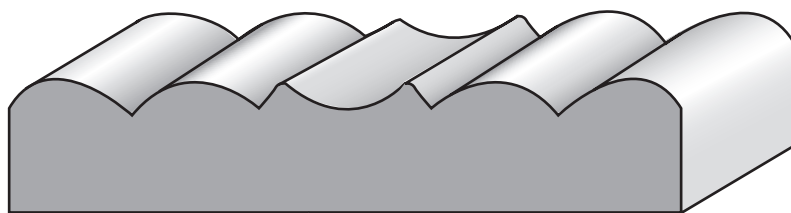

PAC 6193
 11/16 X 3-1/2

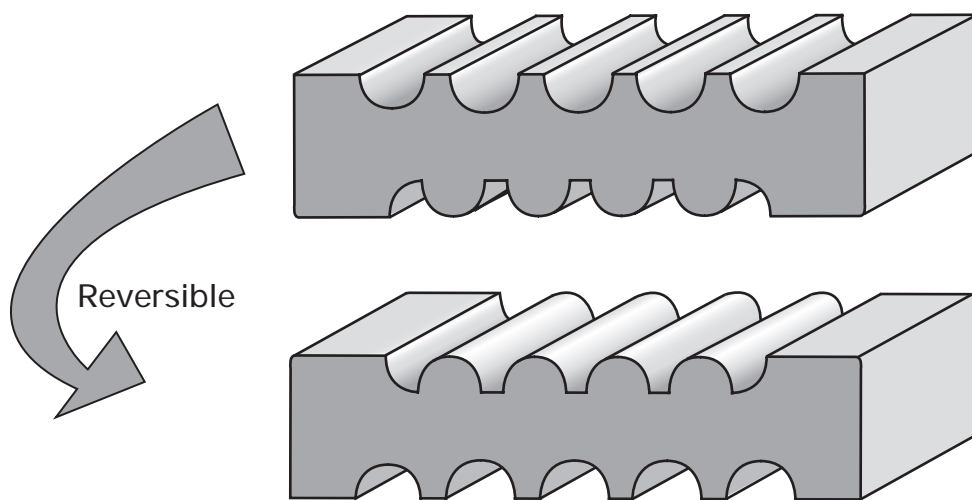

PAC 6189
 3/4 X 3

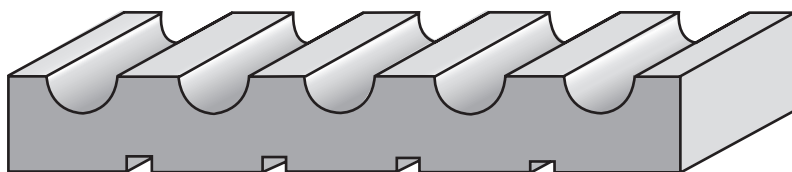

PAC 6167
 1/2 X 3-1/2

PH 714.998.6446

Fx 714.998.6260

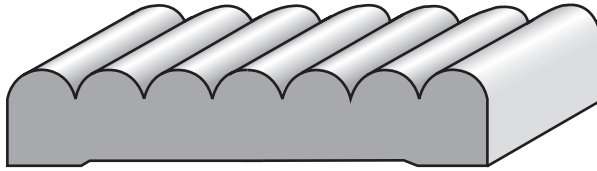

PAC 6188
1/2 X 2-1/2

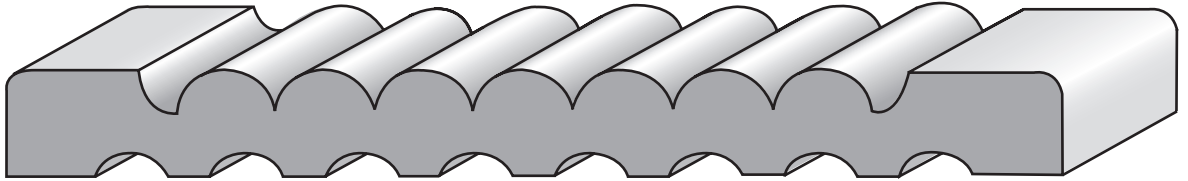

PAC 6125
9/16 X 5-1/2
Reversible

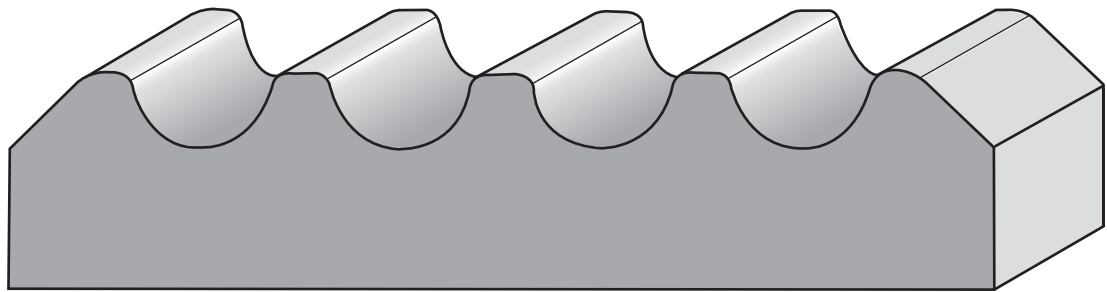

PAC 6190
1-1/8 X 5-1/8

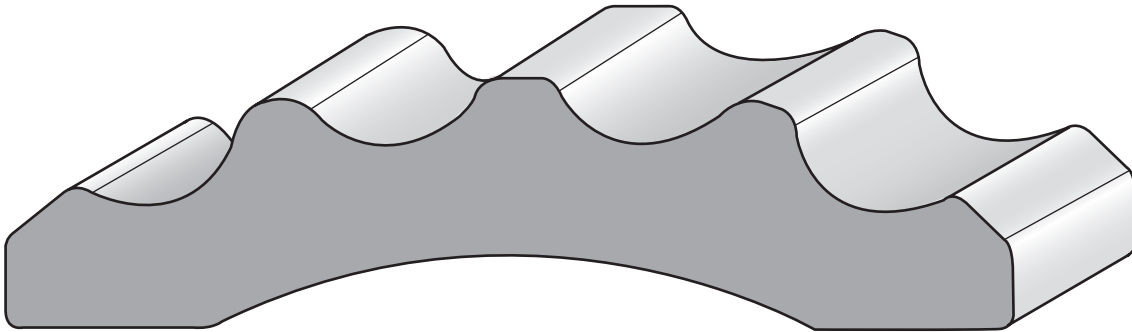

PAC 6191
1-5/16 X 5-1/4

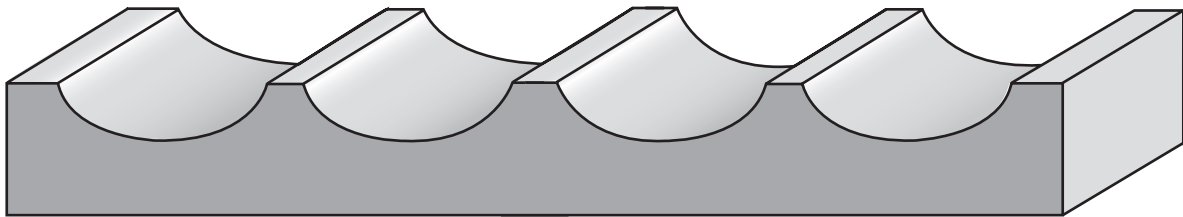

PAC 6192
11/16 X 5-1/2

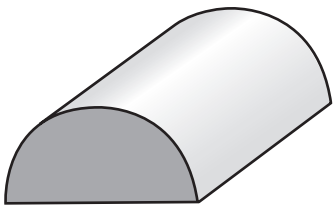

PAC 7515
1/2 X 1

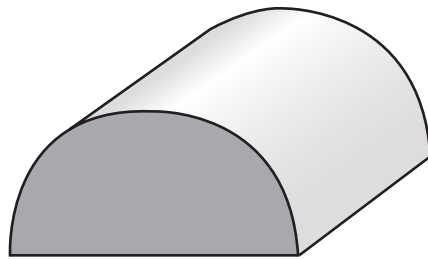

PAC 7516
3/4 X 1-1/2

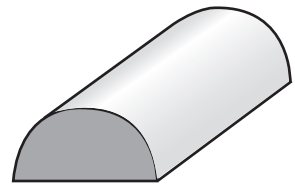

PAC 7517
3/8 X 3/4



pacifi**CH**ARDWOOD
We Measure Up

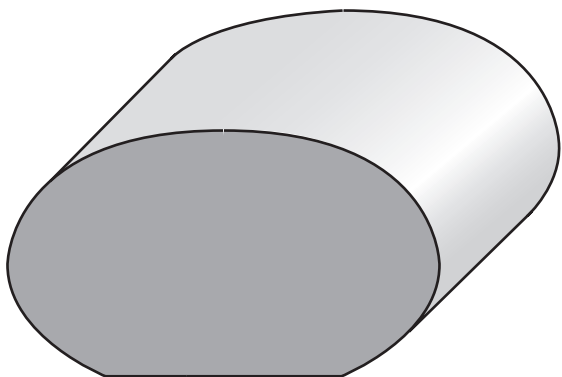

PAC 4100
2-1/4 X 1-9/32

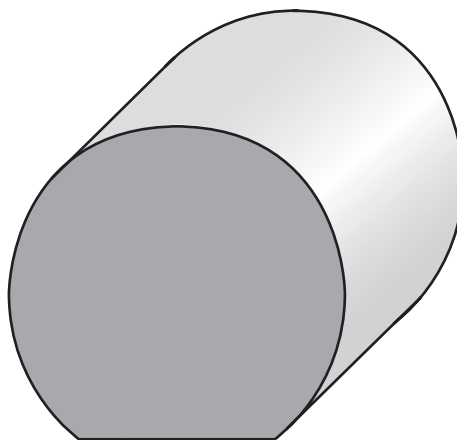

PAC 4101
1-3/4 X 1-5/8

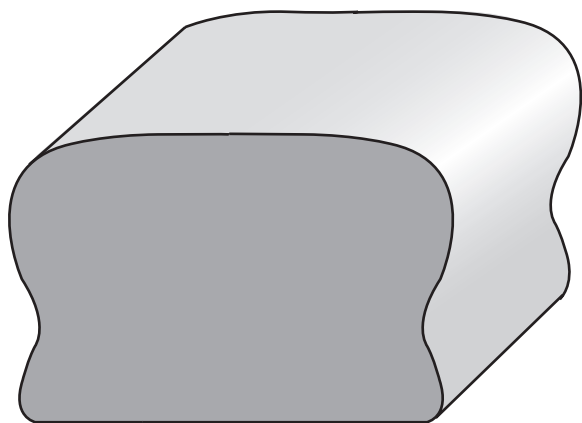

PAC 4104
2-5/16 X 1-1/2

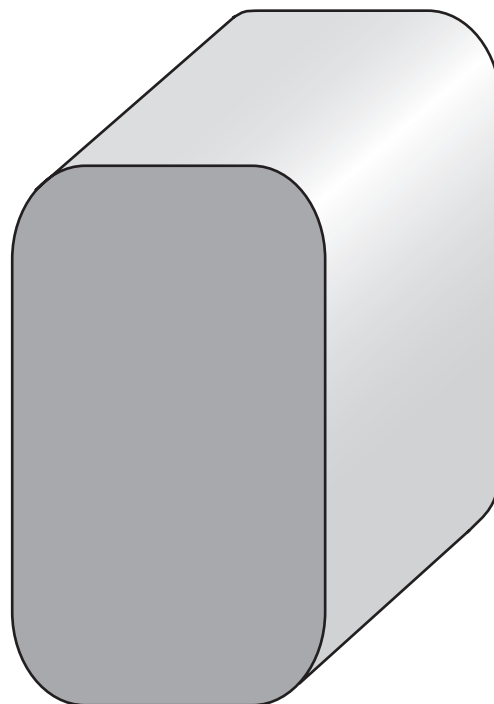

PAC 4105
1-5/8 X 2-13/16

PH 714.998.6446

Fx 714.998.6260

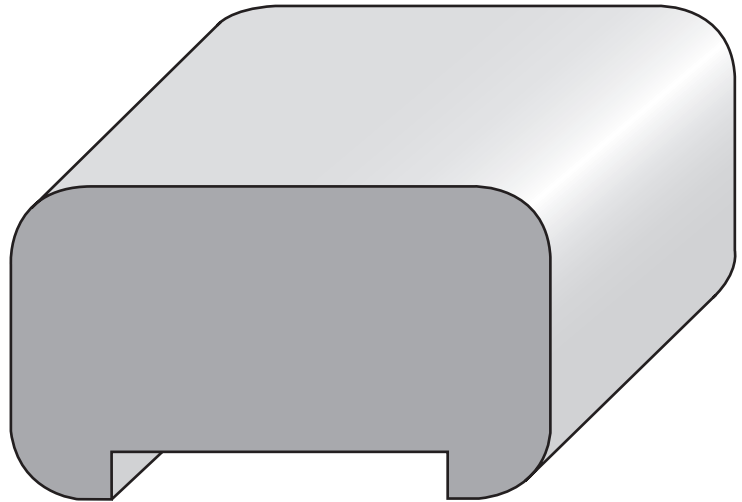

PAC 4102
2-13/16 X 1-5/8

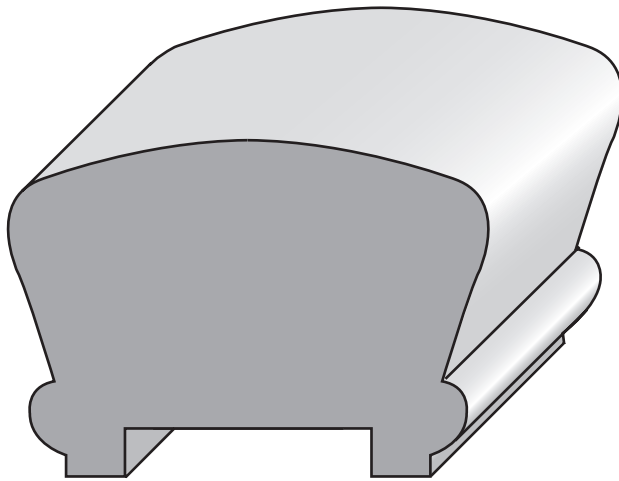

PAC 4103
2-1/2 X 1-3/4

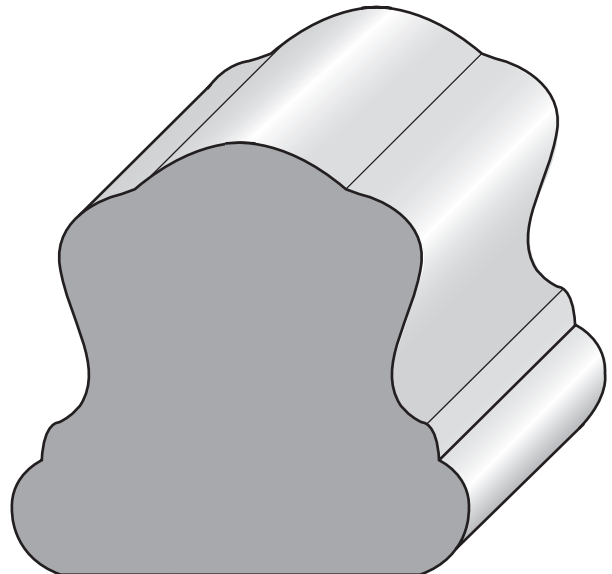

PAC 4106
2-3/8 X 2-1/4



pacifi**C**HARDWOOD
We Measure Up

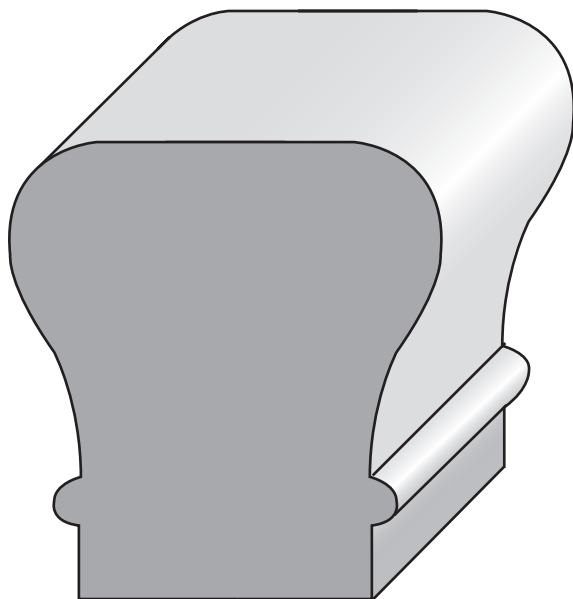

PAC 4107
2-1/4 X 2-3/8

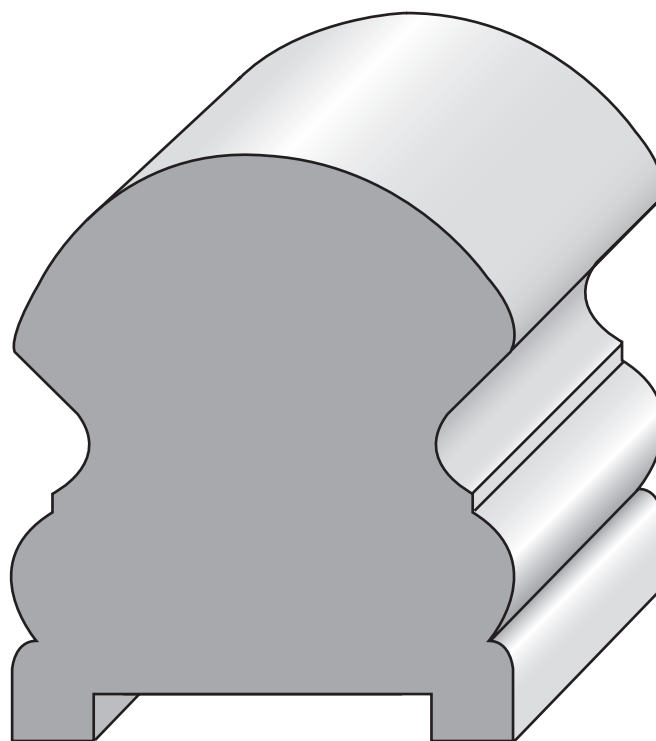

PAC 4112
2-5/8 X 3

PH 714.998.6446

Fx 714.998.6260

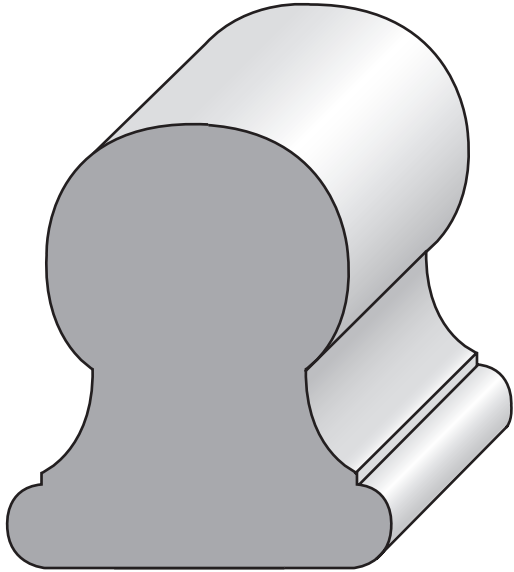

PAC 4110
2 X 2-5/16

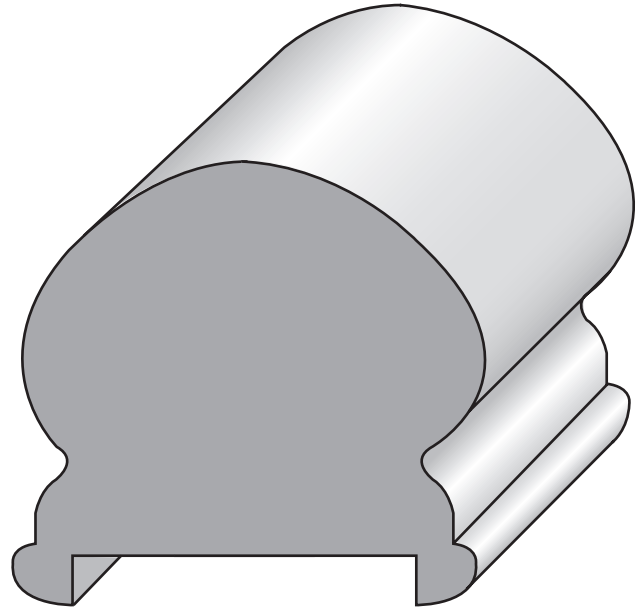

PAC 4111
2-1/2 X 2-5/16

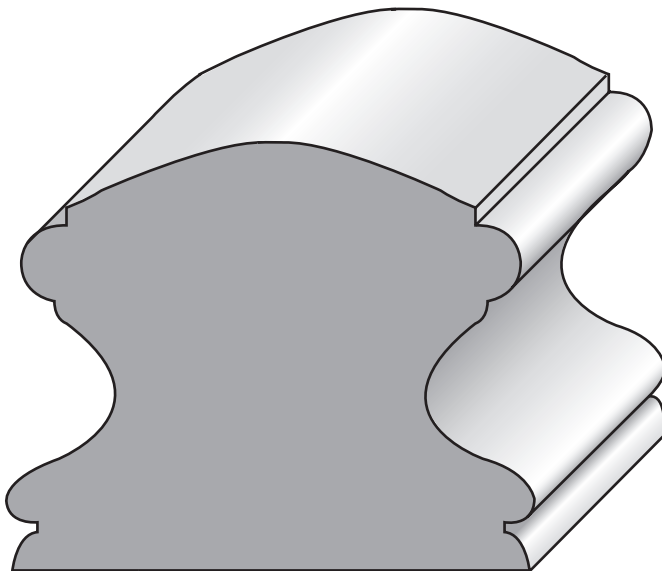

PAC 4109
2-3/4 X 2-1/4



pacifi**C**HARDWOOD
We Measure Up

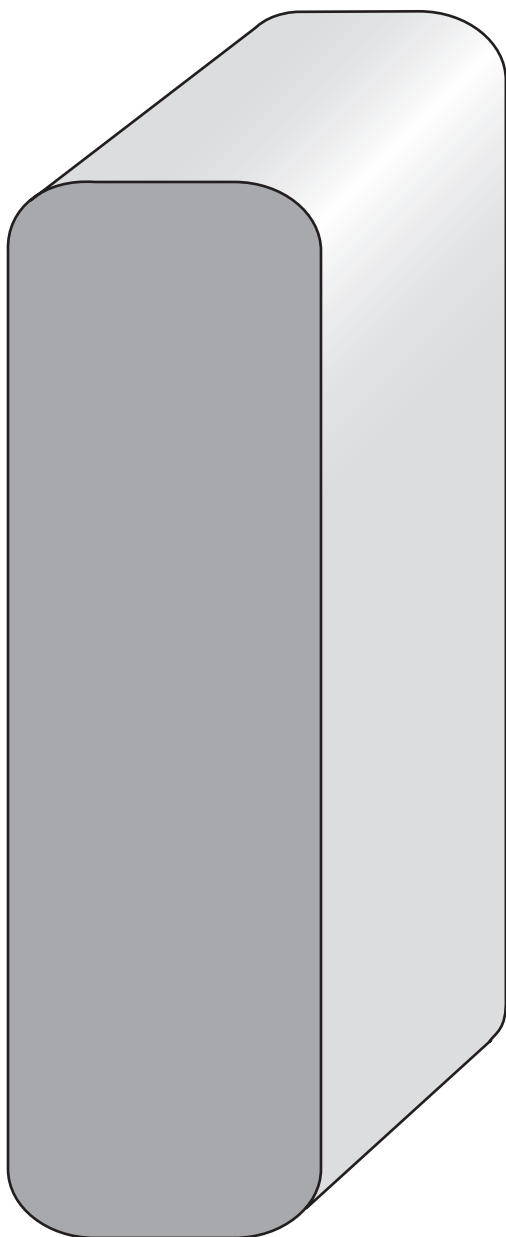

PAC 4113
1-5/8 X 5-1/2

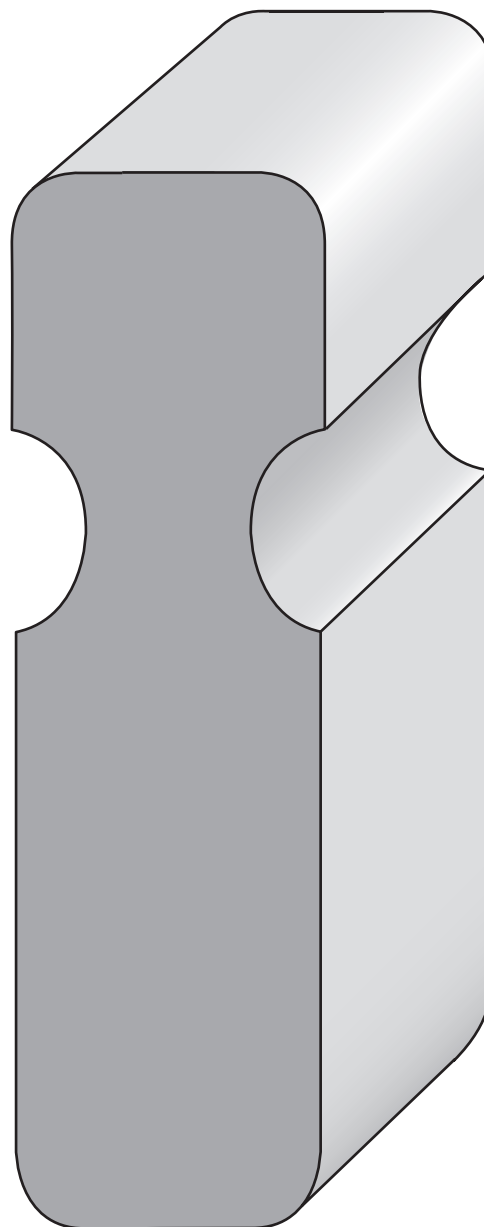

PAC 4114
1-5/8 X 5-1/2

PH 714.998.6446

Fx 714.998.6260

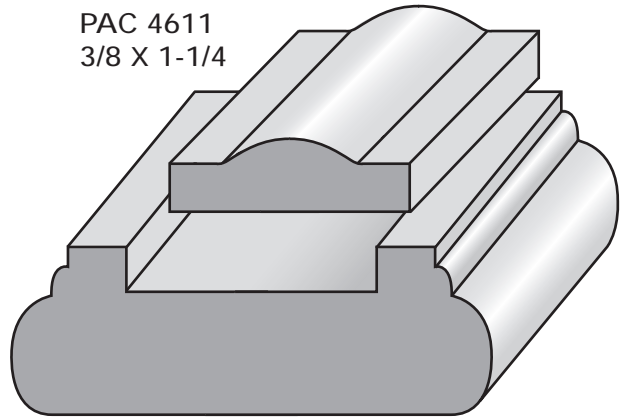

PAC 4611
3/8 X 1-1/4



PAC 4612
3/4 X 2-1/2

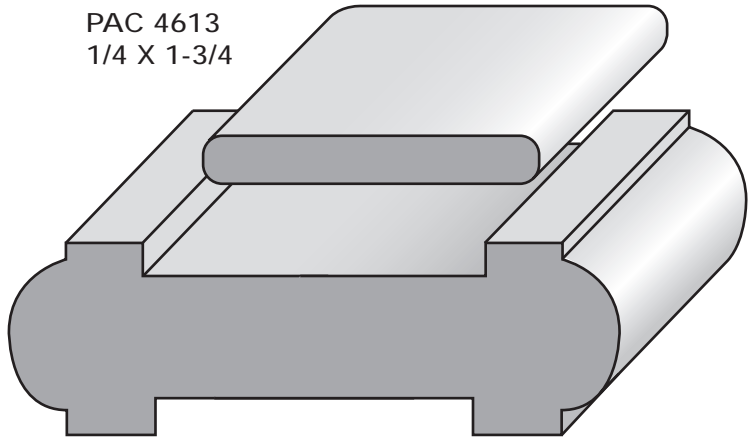

PAC 4613
1/4 X 1-3/4

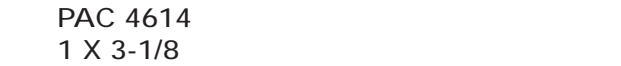

PAC 4614
1 X 3-1/8



pacifi**C**HARDWOOD
We Measure Up

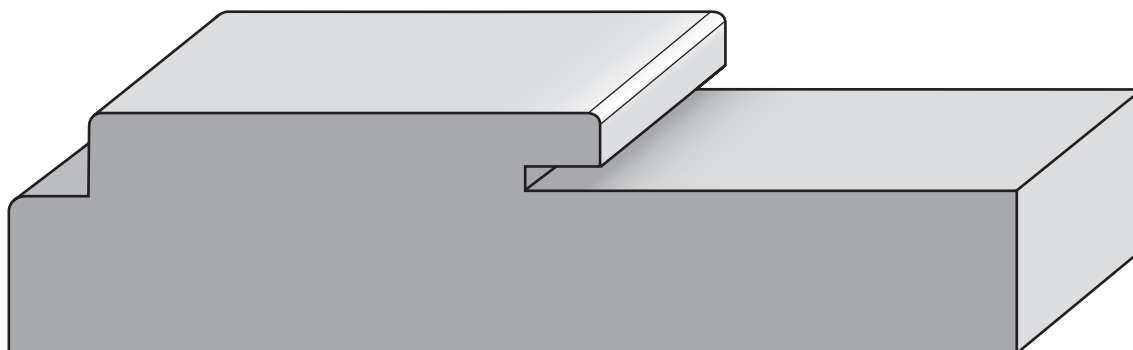

PAC 5513
1-1/4 X 5-1/4

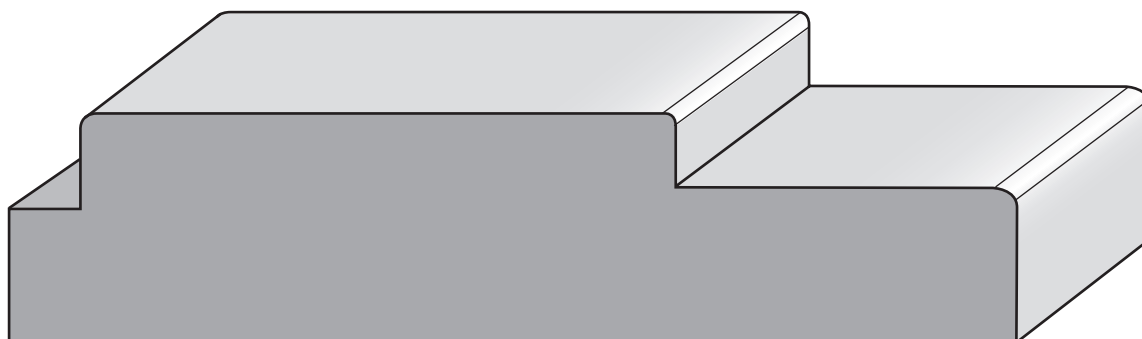

PAC 5514
1-3/16 X 5-1/4

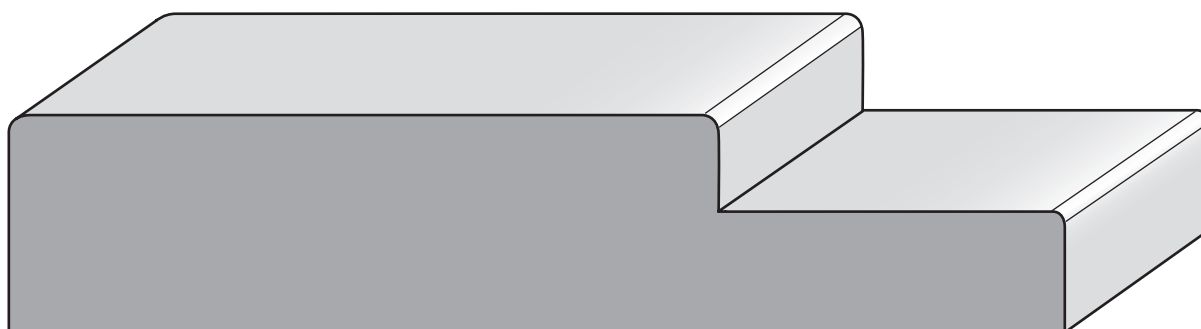

PAC 5515
1-1/8 X 5-1/2

PH 714.998.6446

Fx 714.998.6260



PAC 5516
1-1/8 X 7-1/2
(90 % actual size)



PAC 5510
11/16 X 4-9/16



PAC 5511
11/16 X 4-3/4



PAC 5512
11/16 X 5-1/4



pacificHARDWOOD
We Measure Up

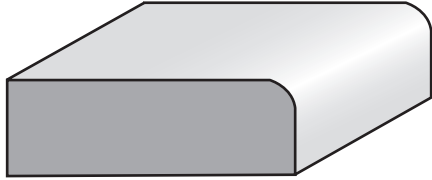

PAC 7510
 1/2 X 1-1/2

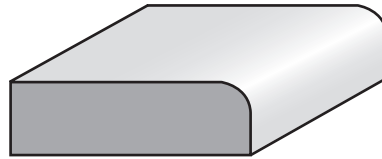

PAC 7511
 3/8 X 1-1/4

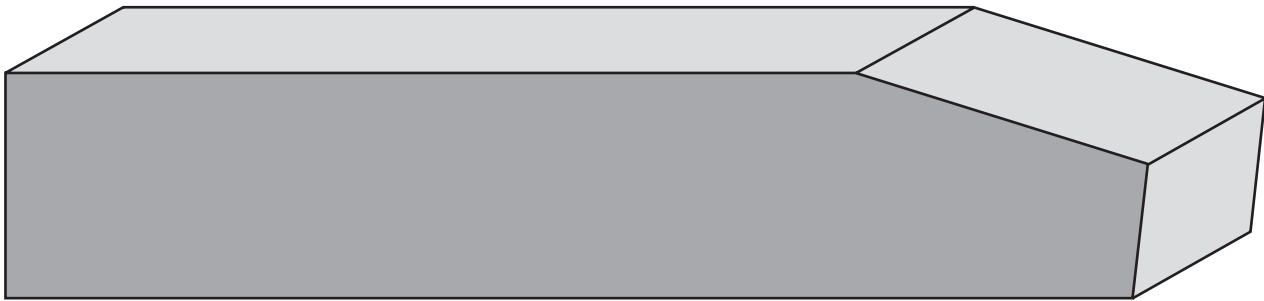

PAC 1510
 1-3/8 X 7

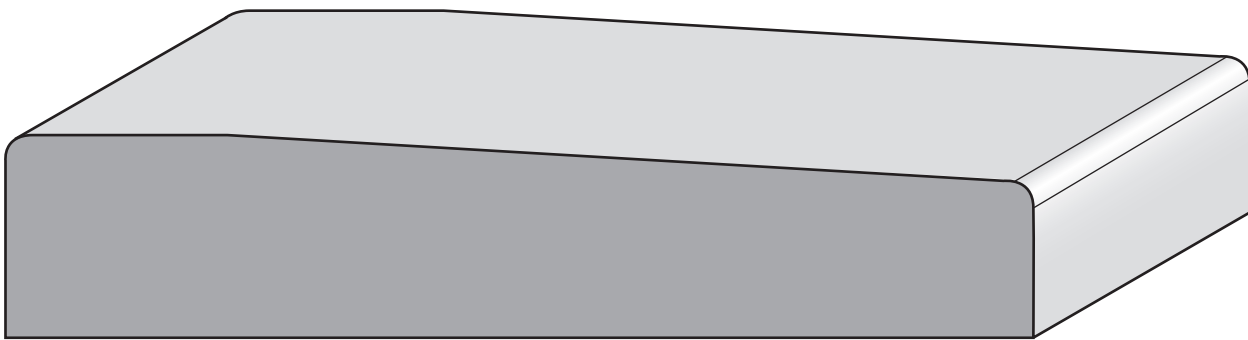

PAC 1511
 1-3/8 X 7
 90% actual size

www.pacifichardwood.com

PH 714.998.6446

Fx 714.998.6260

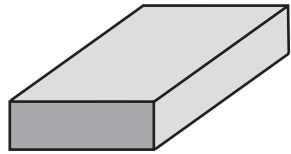

PAC 7901
1/4 X 3/4

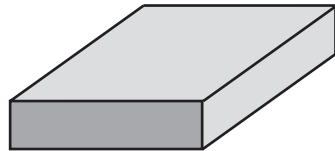

PAC 7902
1/4 X 1



PAC 7903
1/4 X 1-3/4



PAC 7904
1/4 X 2-1/2



PAC 7905
1/4 X 3-1/2

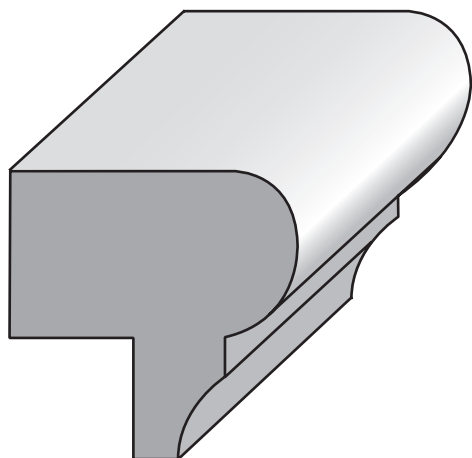

PAC 5107
1-1/2 X 1-1/2

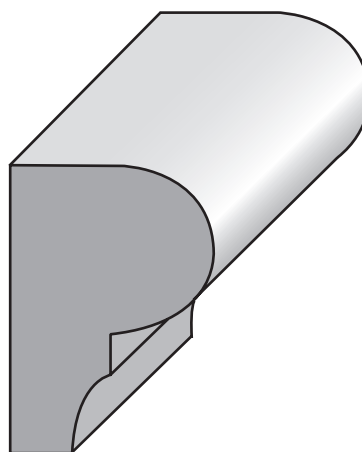

PAC 5108
1-1/2 X 1-1/16

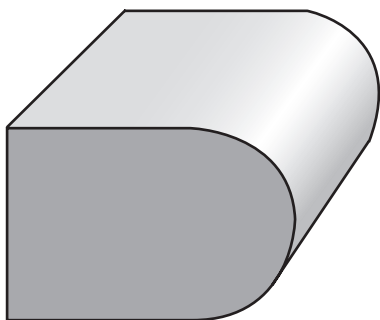

PAC 5110
1 X 1-1/2

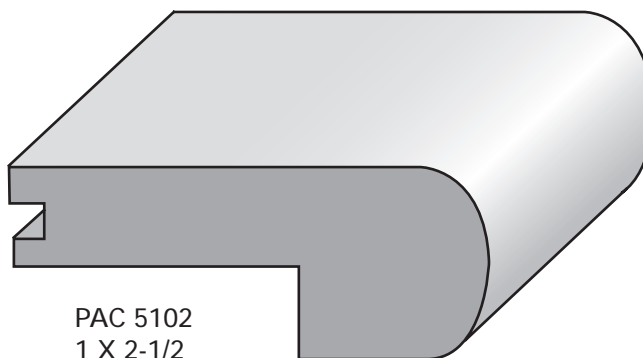

PAC 5102
1 X 2-1/2

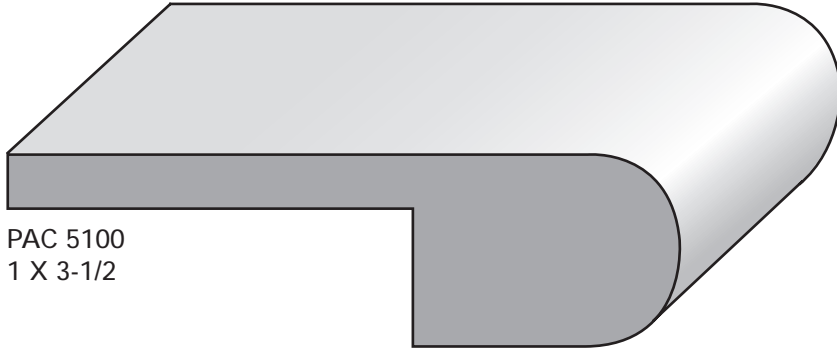

PAC 5100
1 X 3-1/2

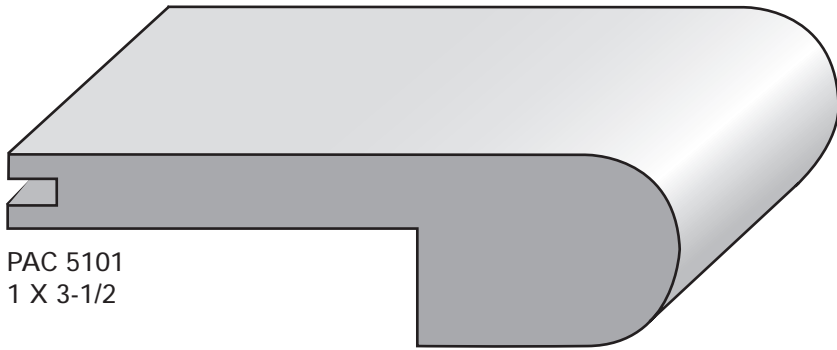

PAC 5101
1 X 3-1/2



PAC 5105
1 X 5-1/2



PAC 5103
1 X 3-1/2



pacifi**CH**ARDWOOD
We Measure Up

Nosing

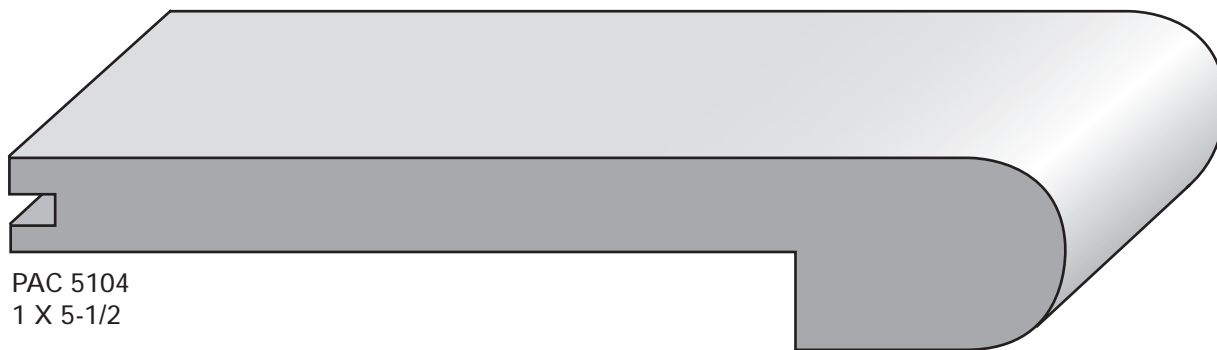

PAC 5104
1 X 5-1/2

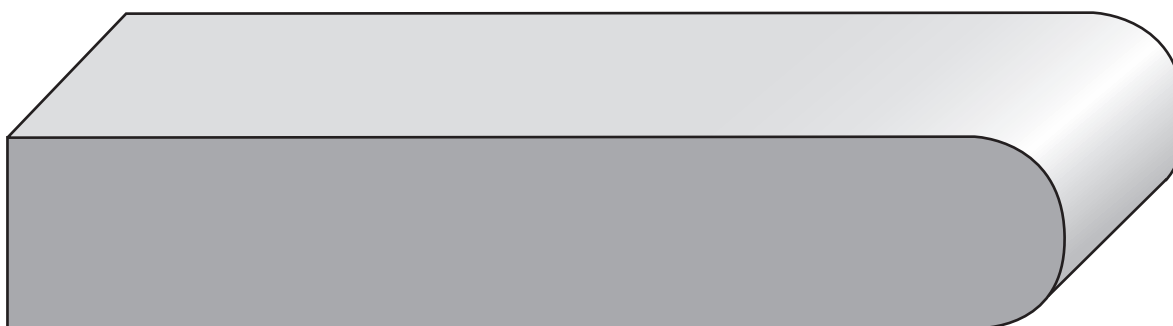

PAC 5106
1 X 5-1/2

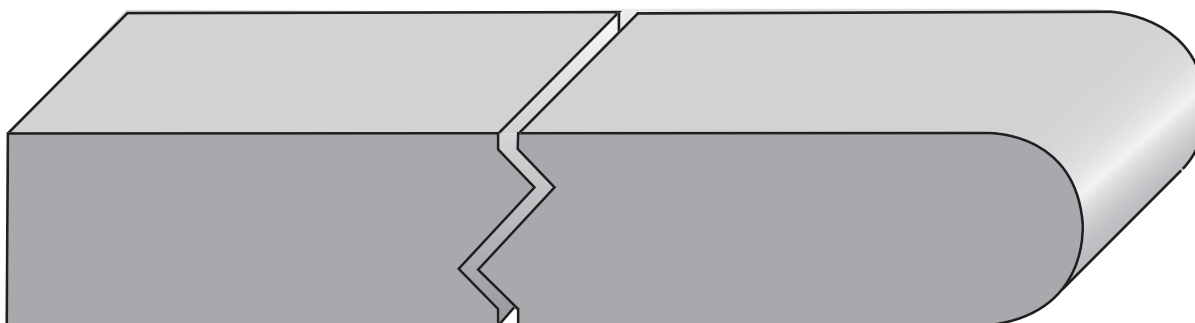

PAC 5119
1 X 11-1/4

PH 714.998.6446

Fx 714.998.6260



pacificHARDWOOD
We Measure Up

Panel
 Moulding

www.pacifichardwood.com

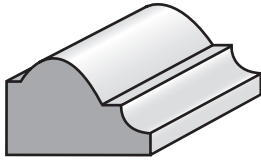

PAC 1100
 1/2 X 3/4

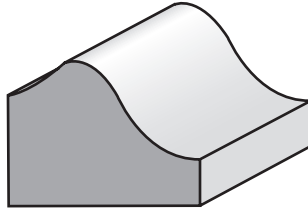

PAC 1103
 3/4 X 1

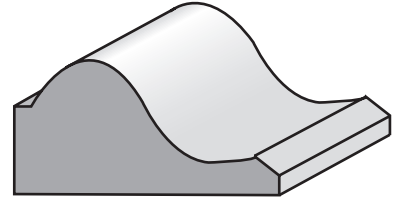

PAC 1106
 11/16 X 1-3/8

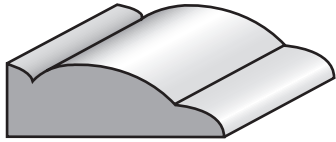

PAC 1109
 3/8 X 1-1/8

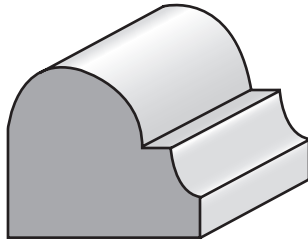

PAC 1101
 7/8 X 1

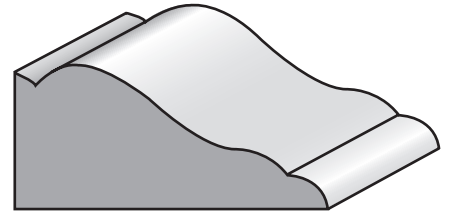

PAC 1104
 3/4 X 1-5/8

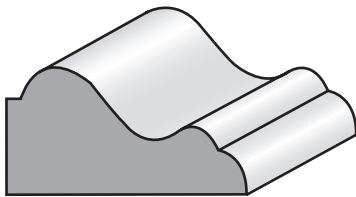

PAC 1107
 21/32 X 1-1/4

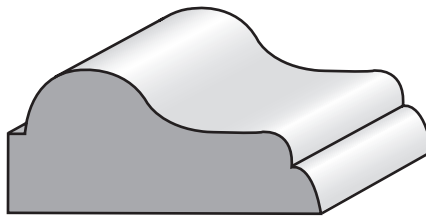

PAC 1102
 3/4 X 1-5/8

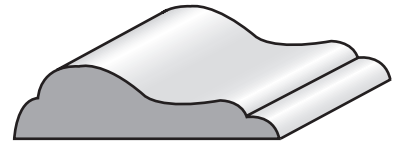

PAC 1110
 3/8 X 1-3/8



pacifiHARDWOOD
We Measure Up

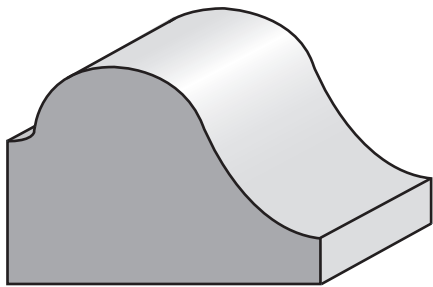

PAC 1105
 1-1/8 X 1-5/8

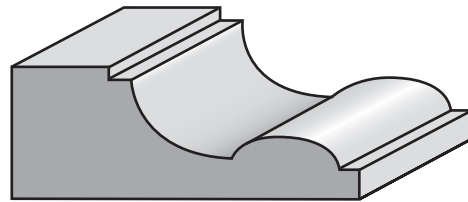

PAC 1108
 11/16 X 1-13/16

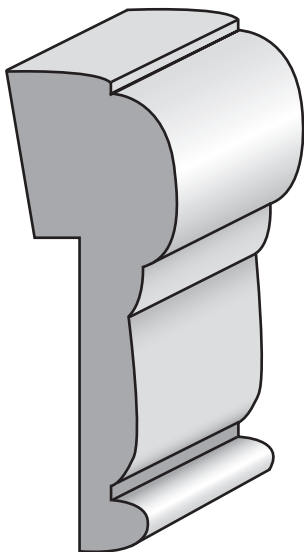

PAC 8100
 7/8 X 2-1/2

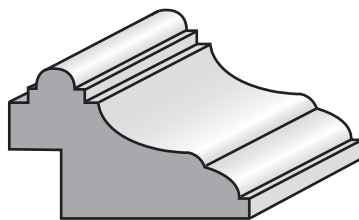

PAC 8104
 25/32 X 1-1/4

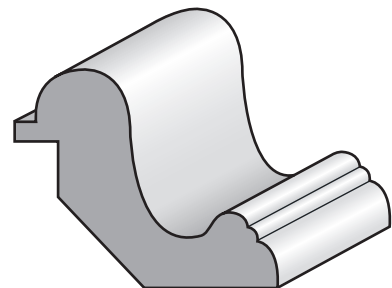

PAC 8103
 1-1/8 X 1-5/16

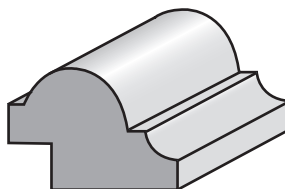

PAC 8102
 5/8 X 7/8

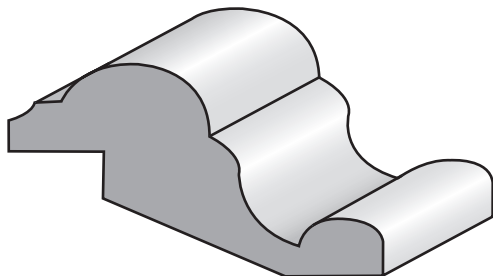

PAC 8105
 3/4 X 2

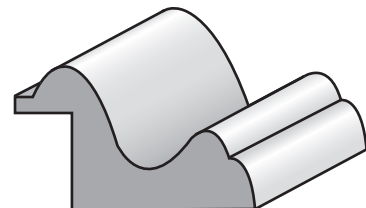

PAC 8110
 3/4 X 1-1/4

www.pacifichardwood.com

PH 714.998.6446

Fx 714.998.6260

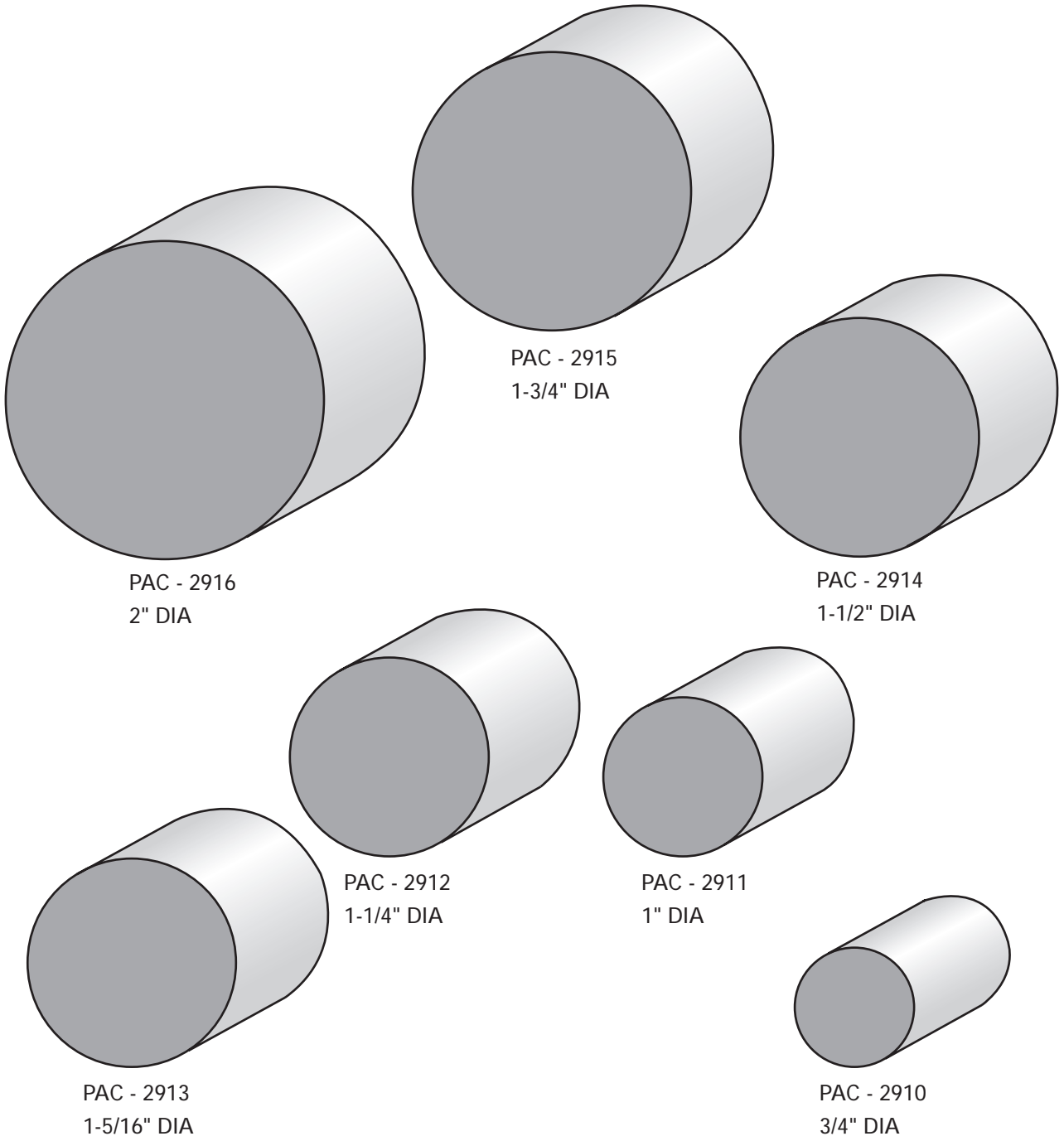



S4S lumber, or lumber surfaced 4 sides, can be produced to your specifications from a wide variety of species. S4S lumber is typically planed on the two wide faces, and smooth-ripped to width. Available lengths and other characteristics vary with species. Call our office for details.

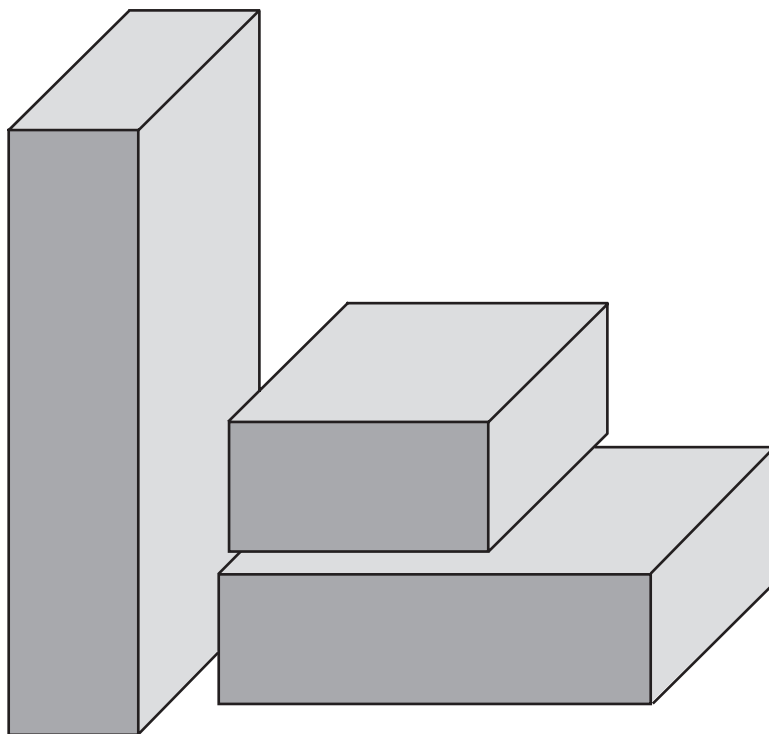

Nominal Size	Net Size	Stock Number
1 x 2	3/4" or 25/32" x 1-1/2"	Pac 3914
1 x 3	3/4" or 25/32" x 2-1/2"	Pac 3915
1 x 4	3/4" or 25/32" x 3-1/2"	Pac 3916
1 x 6	3/4" or 25/32" x 5-1/4"	Pac 3917
1 x 8	3/4" or 25/32" x 7-1/4"	Pac 3918
1 x 10	3/4" or 25/32" x 9-1/4"	Pac 3919
1 x 12	3/4" or 25/32" x 11-1/4"	Pac 3920

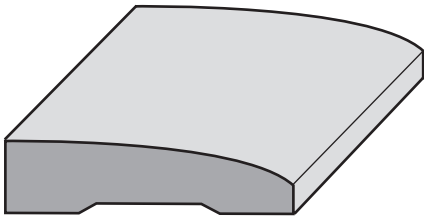

PAC 1912
3/8 X 1-1/2

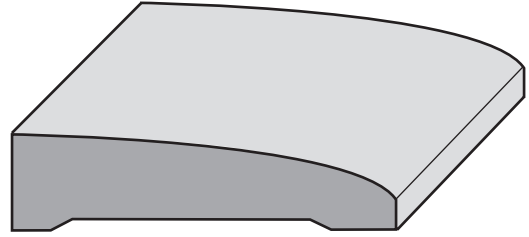

PAC 1911
1/2 X 2

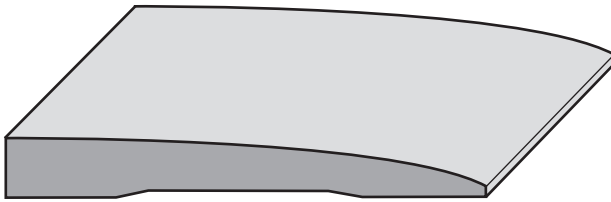

PAC 1910
5/16 X 2-1/2

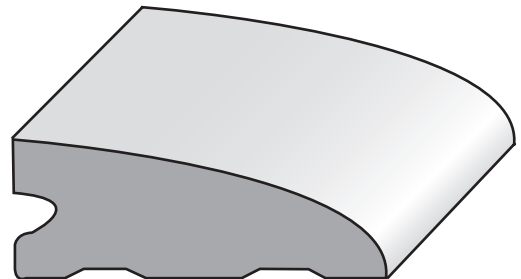

PAC 1913
3/4 X 2



pacifi**CH**ARDWOOD
We Measure Up

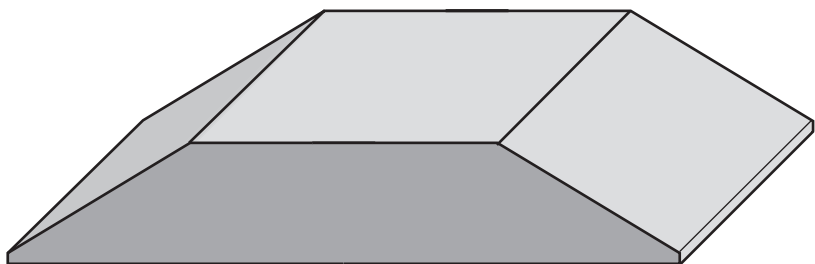

PAC 2515
5/8 X 3-1/2

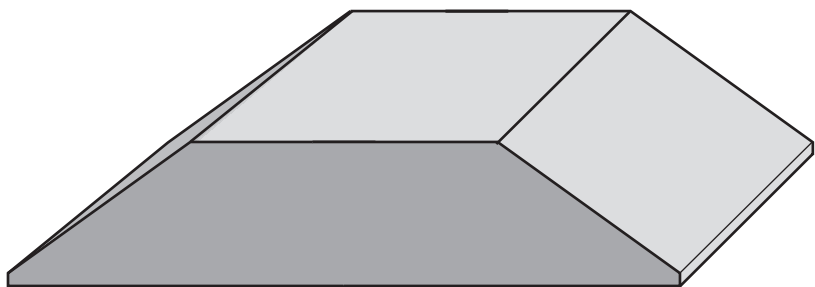

PAC 2514
3/4 X 3-1/2

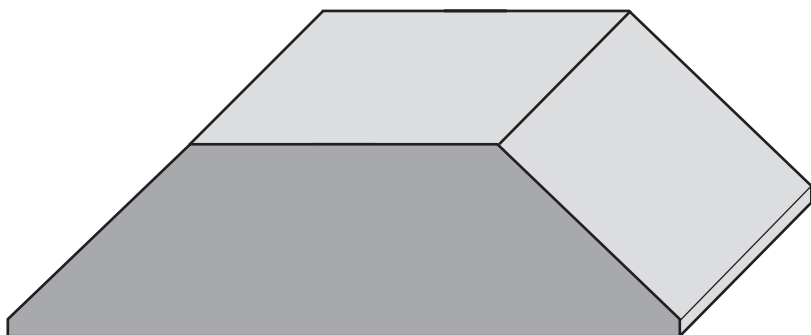

PAC 2516
1 X 3-1/2



PAC 2513
3/4 X 5-1/2

PH 714.998.6446

Fx 714.998.6260

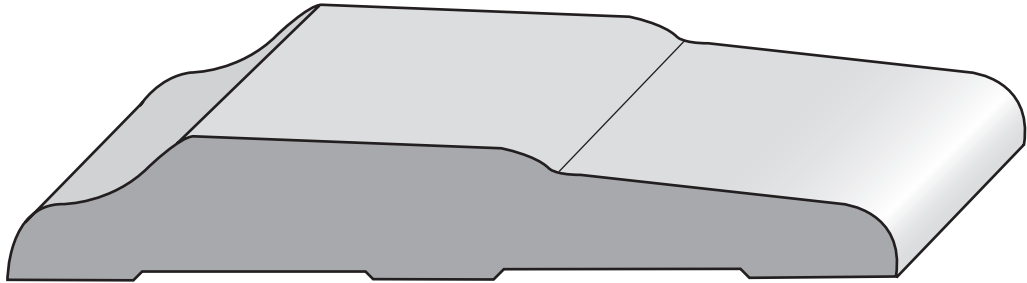

PAC 2512
3/4 X 4-5/8

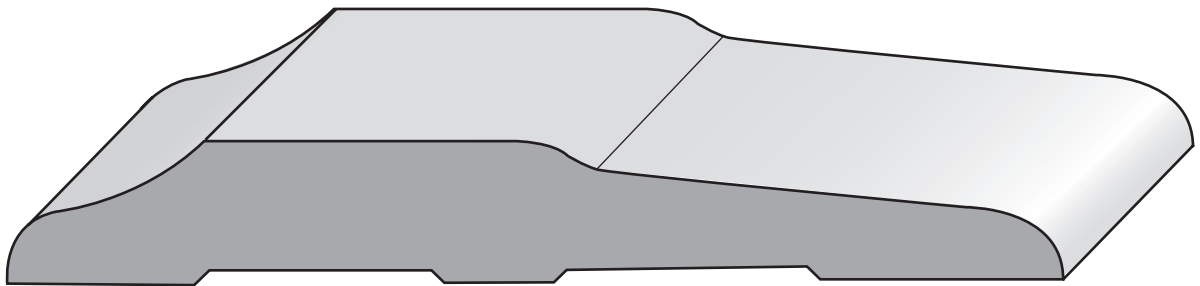

PAC 2511
3/4 X 5-1/2

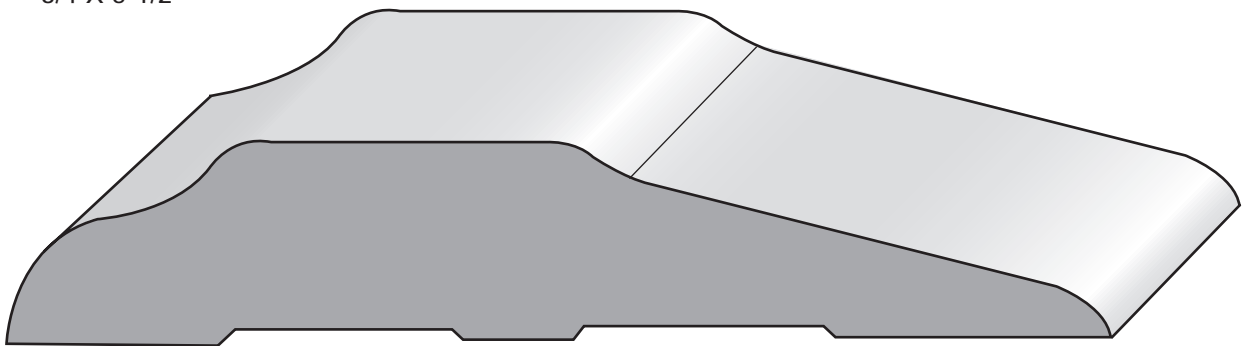

PAC 2510
1-1/16 X 5-3/4

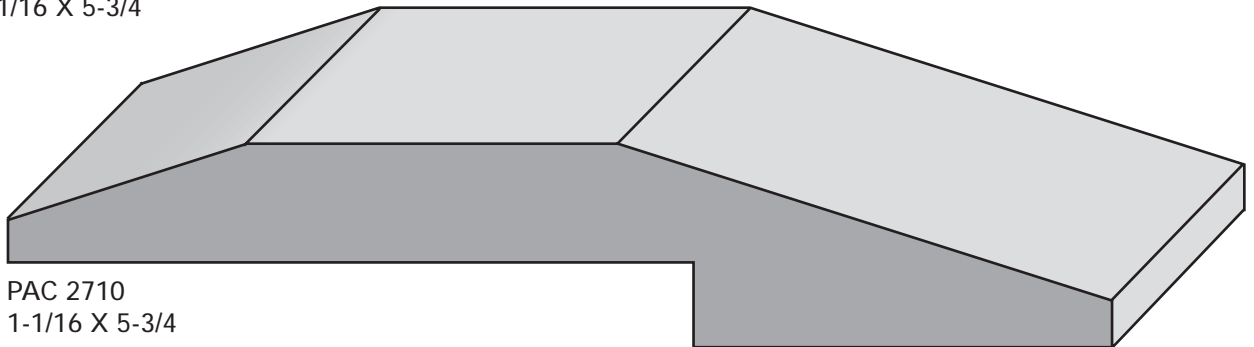

PAC 2710
1-1/16 X 5-3/4

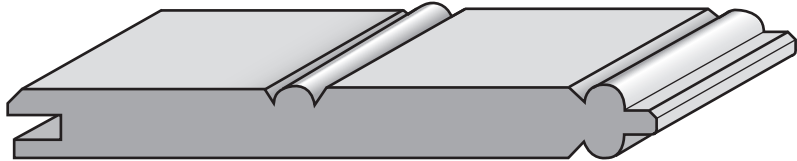

PAC 8510
3/8 X 3-3/8
(3-1/4" Face)

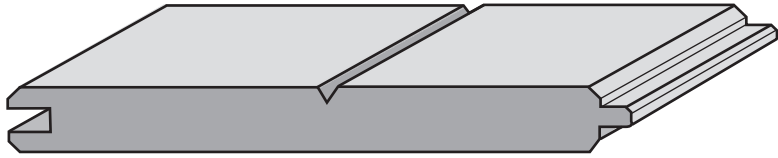

PAC 8511
11/32 X 3-1/4
(3-1/4" Face)
(Reversible For Single or Double)

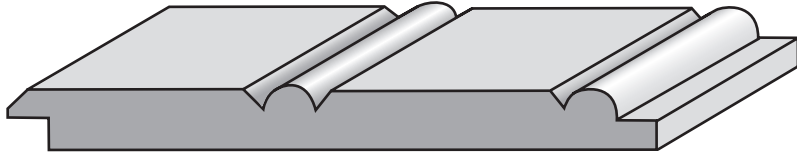

PAC 8512
5/16 X 3-3/8
(3-1/4" Face)

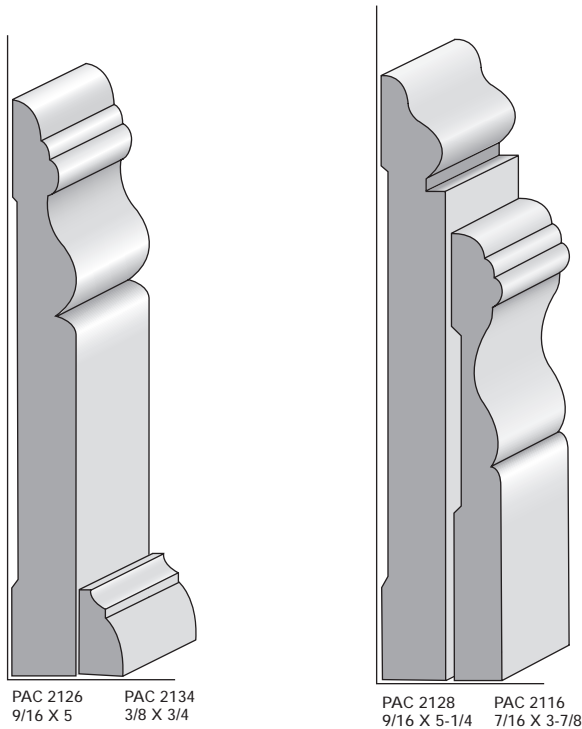
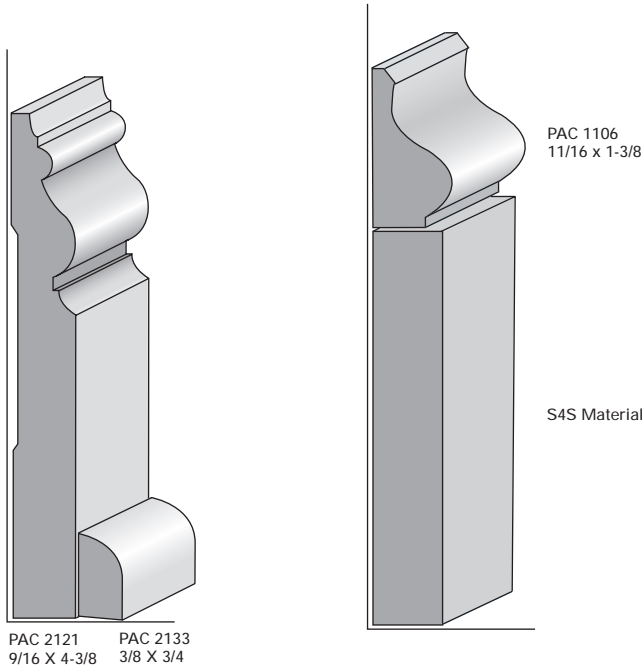

Mouldings can be combined to produce larger and more visually interesting effects. Base shoe can be added to virtually any base to add thickness and to secure a tighter joint with the floor. In larger rooms and commercial installation, bases are combined to produce details of greater mass. Panel mouldings and panel caps are often added to the top edge of standard S4S material to produce tall base treatments.



pacifi**C**HARDWOOD

We Measure Up

Build-Ups

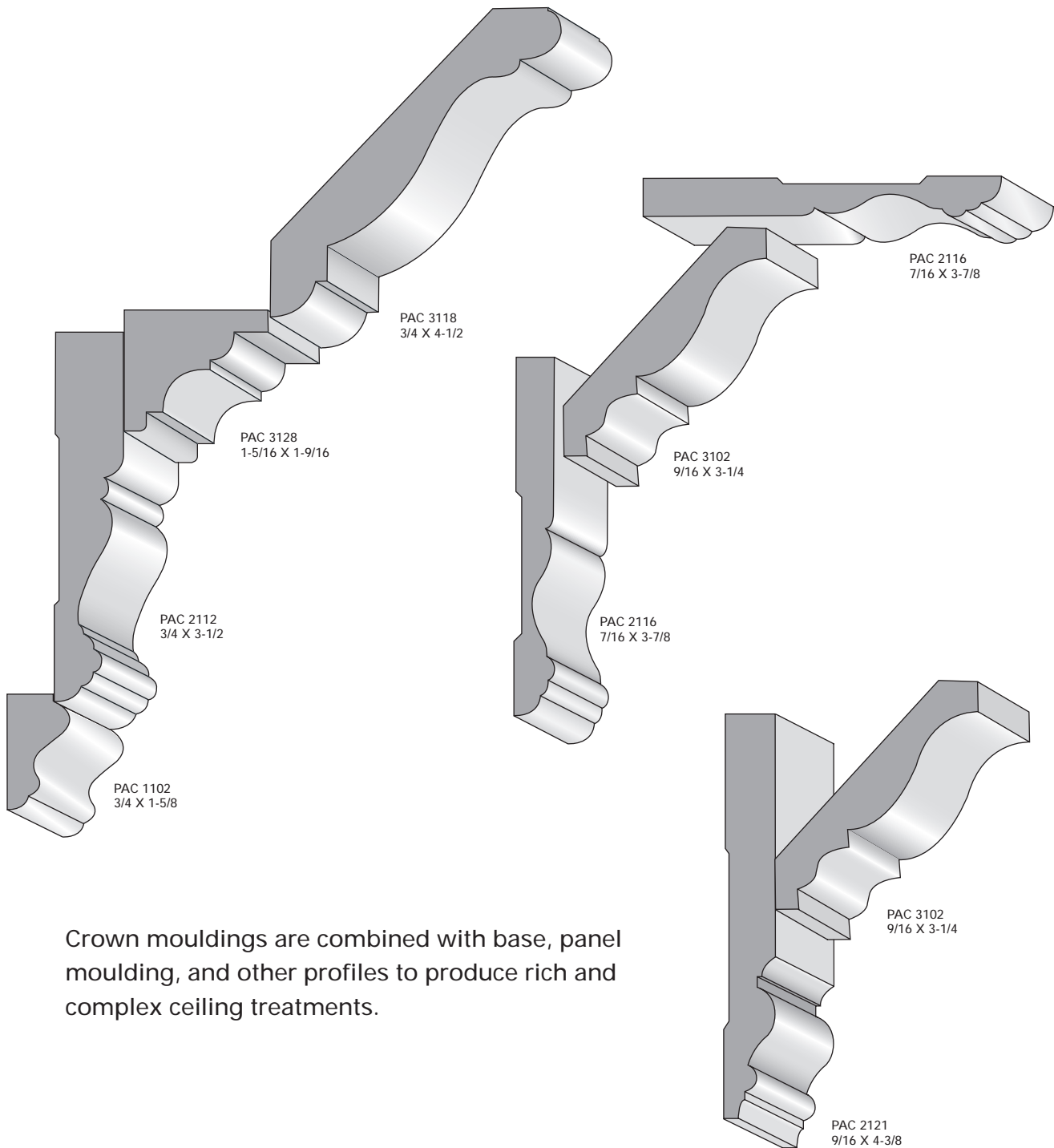

Crown mouldings are combined with base, panel moulding, and other profiles to produce rich and complex ceiling treatments.

PH 714.998.6446

Fx 714.998.6260

www.pacifichardwood.com



pacifi**C**HARDWOOD

We Measure Up

Build-Ups

www.pacifichardwood.com

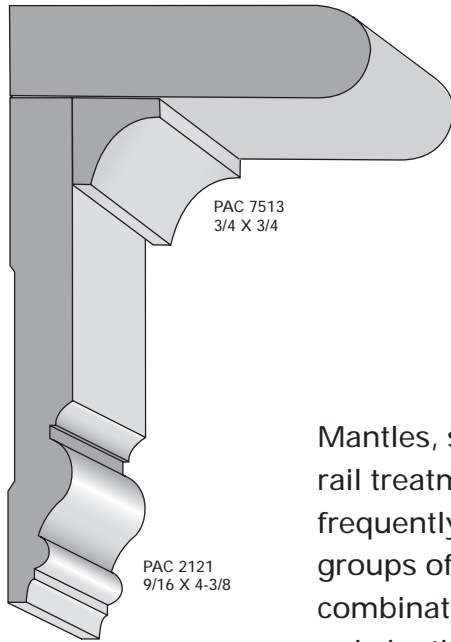

PAC 7513
3/4 X 3/4

PAC 2121
9/16 X 4-3/8

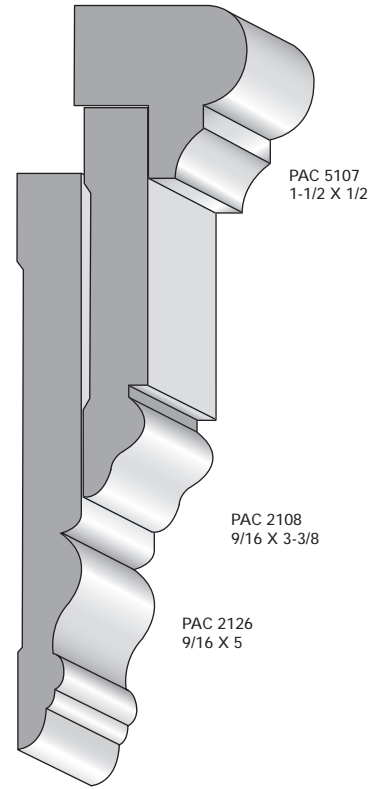

PAC 5107
1-1/2 X 1/2

PAC 2108
9/16 X 3-3/8

PAC 2126
9/16 X 5

Mantles, shelves, and chair rail treatments are frequently assembled from groups of mouldings. These combinations are limited only by the imagination.

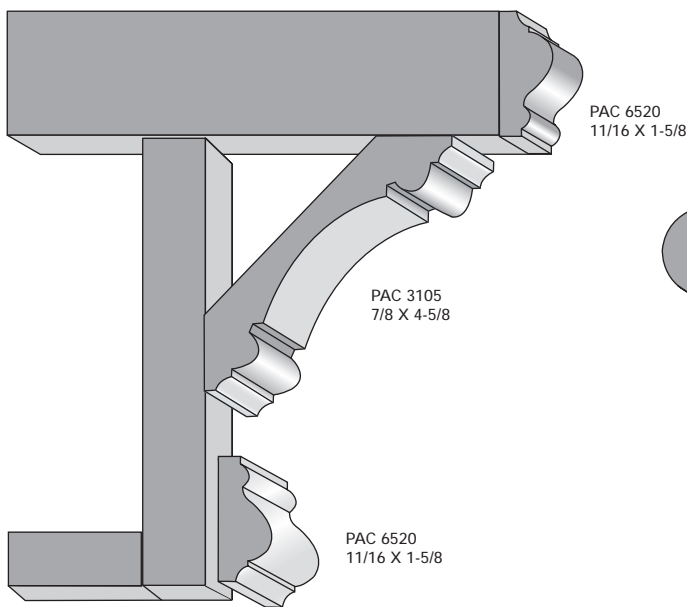

PAC 6520
11/16 X 1-5/8

PAC 3105
7/8 X 4-5/8

PAC 6520
11/16 X 1-5/8

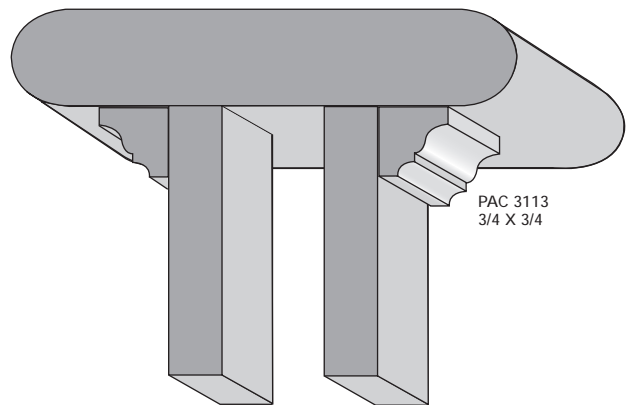

PAC 3113
3/4 X 3/4



pacifi**H**ARDWOOD
We Measure Up

INDEX

PH 714.998.6446

Fx 714.998.6260



PAC 1100
1/2 x 3/4
Page 54

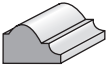

PAC 1101
7/8 x 1
Page 54

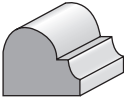

PAC 1107
21/32 x 1-1/4
Page 12, 54

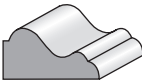

PAC 1103
3/4 x 1
Page 12, 54

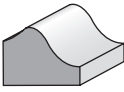

PAC 1104
3/4 x 1-5/8
Page 12, 54



PAC 1105
1-1/8 x 1-5/8
Page 55

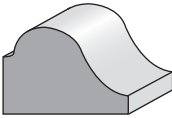

PAC 1106
11/16 x 1-3/8
Page 12, 54

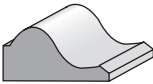

PAC 1102
3/4 x 1-5/8
Page 12, 54



PAC 1108
11/16 x 1-13/16
Page 55

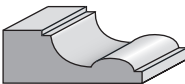

PAC 1109
3/8 x 1-1/8
Page 54



PAC 1110
3/8 x 1--3/8
Page 54

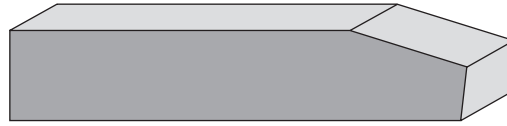

PAC 1510
1-3/8 x 7
Page 49

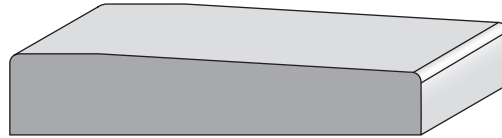

PAC 1511
1-3/8 x 7
Page 49

PAC 1910
5/16 x 2-1/2
Page 58

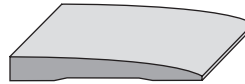

PAC 1911
1/2 x 2
Page 58

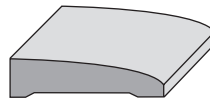

PAC 1912
3/8 x 1-1/2
Page 58

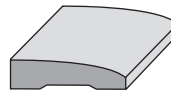

PAC 1913
3/4 x 2
Page 58

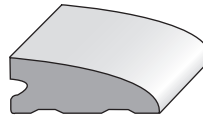

PAC 2100
1/2 x 2-1/2
Page 6

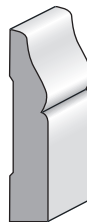

PAC 2101
11/16 x 3-1/4
Page 7

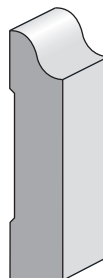

PAC 2102
11/16 x 3-1/4
Page 7

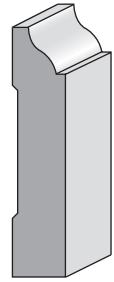

PAC 2103
11/16 x 3-1/4
Page 6

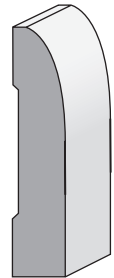

PAC 2104
11/16 X 3-1/4
Page 7

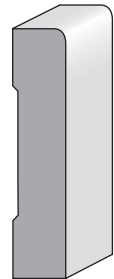



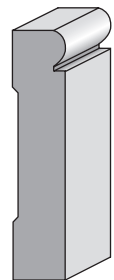

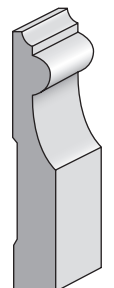

PAC 2105
11/16 x 3-1/4
Page 9

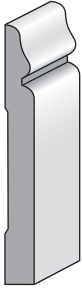
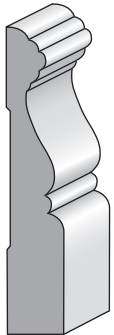

PAC 2106
9/16 x 3-3/8
Page 9

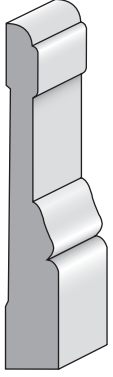
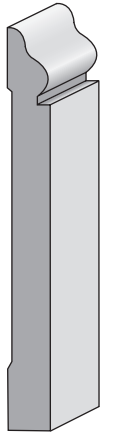
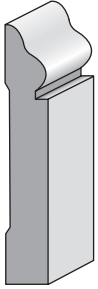
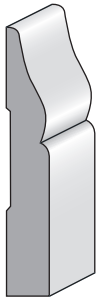
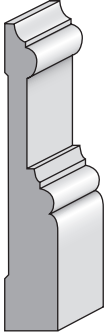
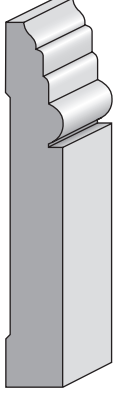
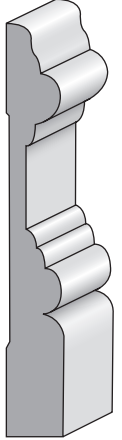
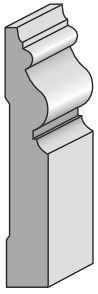
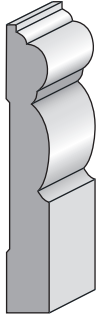
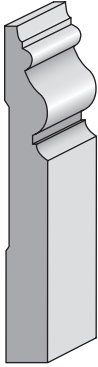
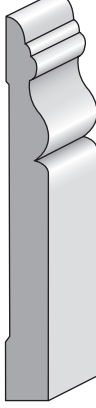
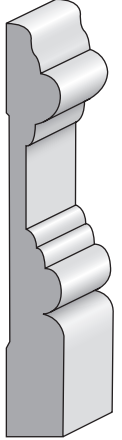
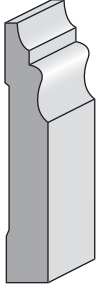

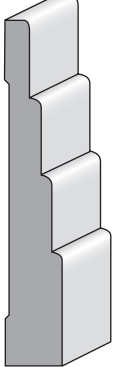
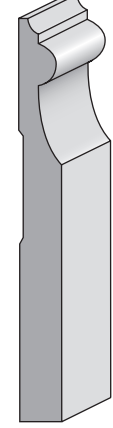
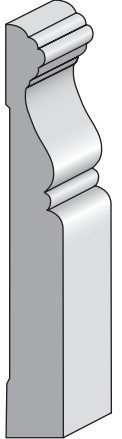
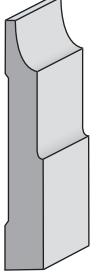

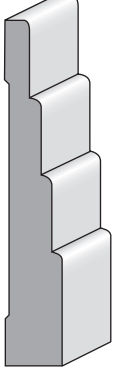
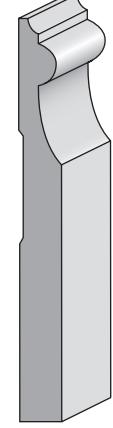
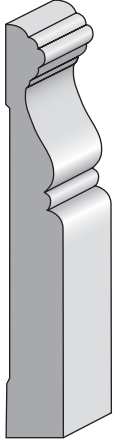
<p>PAC 2107 3/8 x 3-3/8 Page 6</p> 	<p>PAC 2112 3/4 x 3-1/2 Page 7</p> 	<p>PAC 2116 7/16 x 3-7/8 Page 8</p> 	<p>PAC 2123 11/16 x 4-1/2 Page 8</p> 	<p>PAC 2128 9/16 x 5-1/4 Page 10</p> 
<p>PAC 2108 9/16 x 3-3/8 Page 6</p> 	<p>PAC 2113 9/16 x 3-1/2 Page 6</p> 	<p>PAC 2119 11/16 x 4 Page 8</p> 	<p>PAC 2125 3/4 x 4-3/4 Page 9</p> 	<p>PAC 2129 3/4 x 5-3/8 Page 10</p> 
<p>PAC 2109 9/16 x 3-3/8 Page 6</p> 	<p>PAC 2114 9/16 x 3-3/4 Page 7</p> 	<p>PAC 2121 9/16 x 4-3/8 Page 9</p> 	<p>PAC 2126 9/16 x 5 Page 10</p> 	<p>PAC 2129 3/4 x 5-3/8 Page 10</p> 
<p>PAC 2110 9/16 x 3-3/8 Page 6</p> 	<p>PAC 2115 9/16 x 3-7/8 Page 7</p> 	<p>PAC 2122 3/4 x 4-1/2 Page 8</p> 	<p>PAC 2127 9/16 x 5-1/4 Page 10</p> 	<p>PAC 2130 3/4 X 5-3/8 Page 11</p> 
<p>PAC 2111 1/2 x 3-1/2 Page 6</p> 	<p>PAC 2115 9/16 x 3-7/8 Page 7</p> 	<p>PAC 2122 3/4 x 4-1/2 Page 8</p> 	<p>PAC 2127 9/16 x 5-1/4 Page 10</p> 	<p>PAC 2130 3/4 X 5-3/8 Page 11</p> 



PAC 2131
11/16 X 7-3/16
Page 11

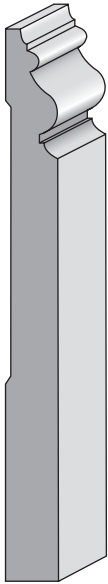

PAC 2132
11/16 x 8
Page 11

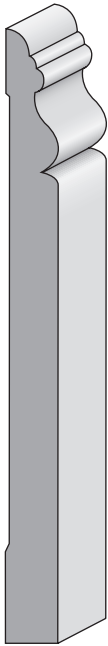

PAC 2133
3/8 x 3/4
Page 8



PAC 2134
3/8 x 3/4
Page 8



PAC 2135
1/2 x 3/4
Page 8



PAC 2510
1-1/16 x 5-3/4
Page 60

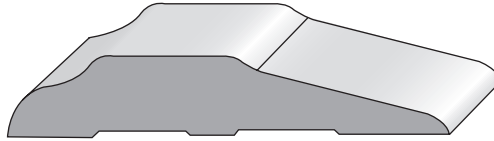

PAC 2511
3/4 x 5-1/2
Page 60

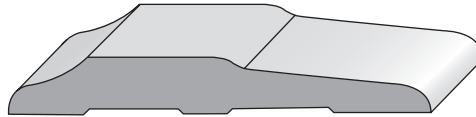

PAC 2512
3/4 x 4-5/8
Page 60

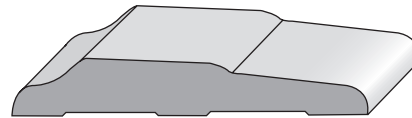

PAC 2513
3/4 x 5-1/2
Page 59



PAC 2514
3/4 x 3-1/2
Page 59

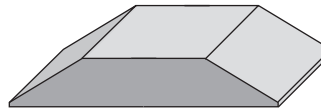

PAC 2515
5/8 x 3-1/2
Page 59

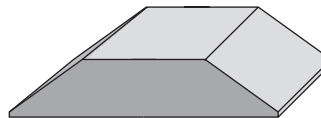

PAC 2516
1 x 3-1/2
Page 59

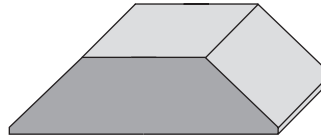

PAC 2710
1-1/16 x 5-3/4
Page 60

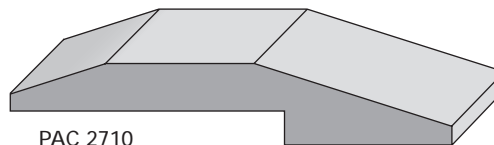

PAC - 2910
3/4" DIA
Page 56

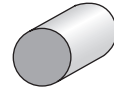

PAC - 2911
1" DIA
Page 56

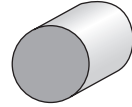

PAC - 2912
1-1/4" DIA
Page 56

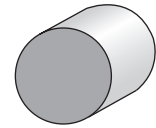

PAC - 2913
1-5/16" DIA
Page 56

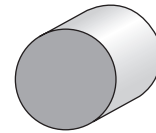

PAC - 2914
1-1/2" DIA
Page 56

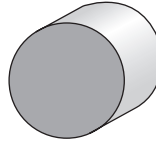

PAC - 2915
1-3/4" DIA
Page 56

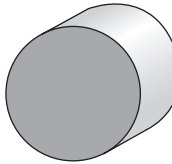

PAC - 2916
2" DIA
Page 56

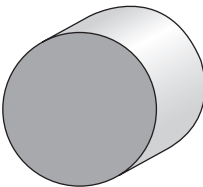

PAC 3100
1-1/16 x 4-5/16
Page 27

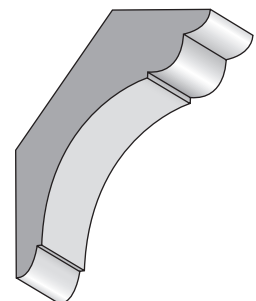



PAC 3101
1-1/8 x 3-3/4
Page 27

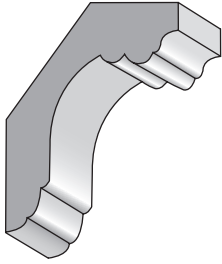

PAC 3102
9/16 x 3-1/4
Page 27

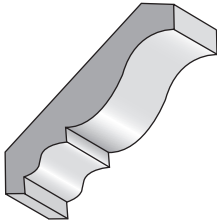

PAC 3103
9/16 x 2-1/2
Page 27

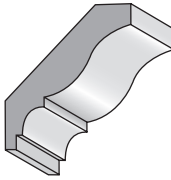

PAC 3104
1-1/8 x 6-1/2
Page 28

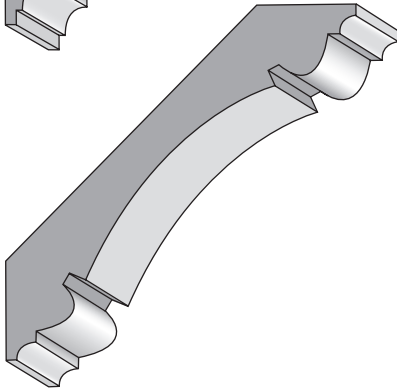

PAC 3105
7/8 x 4-5/8
Page 28

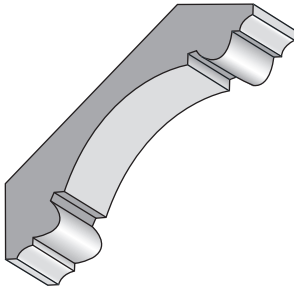

PAC 3106
3/4 x 3-7/16
Page 28

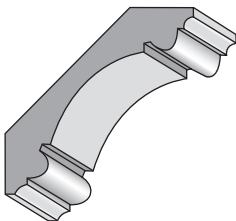

PAC 3107
7/8 x 7-1/4
Page 26

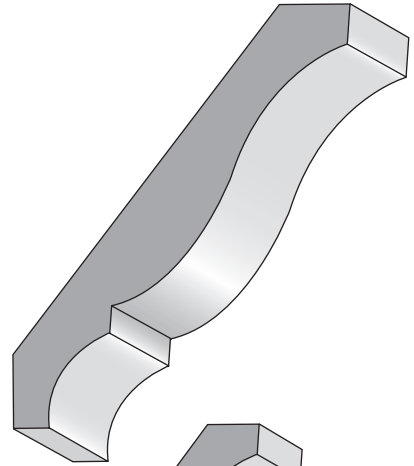

PAC 3108
3/4 x 5-1/4
Page 26

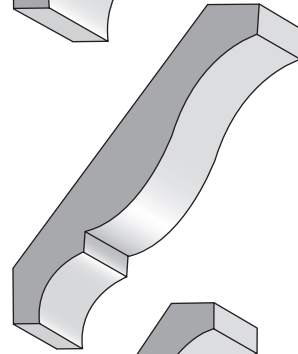

PAC 3109
5/8 x 4-1/2
Page 25

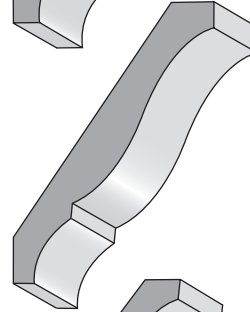

PAC 3110
1/2 x 3-1/2
Page 25

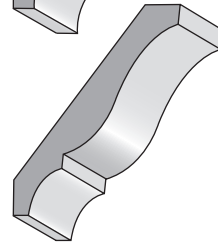

PAC 3111
9/16 x 2-1/4
Page 25

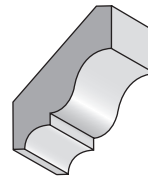

PAC 3112
9/16 x 1-5/8
Page 25

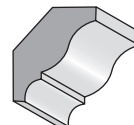



PAC 3113
3/4 x 3/4
Page 25

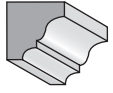

PAC 3114
3/4 x 3-1/4
Page 32

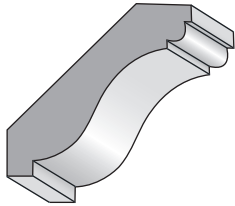

PAC 3115
3/4 x 2-1/4
Page 32

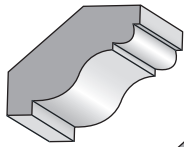

PAC 3116
1-1/4 x 6
Page 31

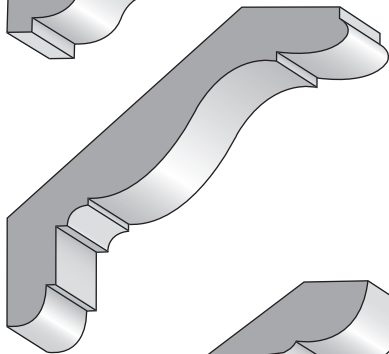

PAC 3117
13/16 x 6
Page 31

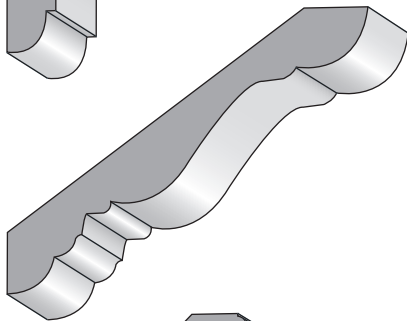

PAC 3118
3/4 x 4-1/2
Page 31

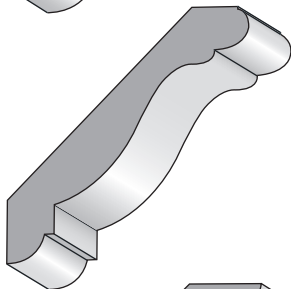

PAC 3119
3/4 x 4-1/2
Page 29

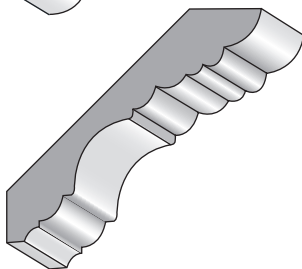

PAC 3120
9/16 x 3-7/16
Page 29

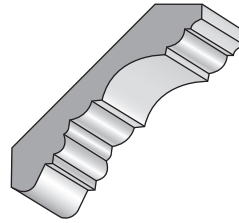

PAC 3122
1/2 x 2-1/4
Page 29



PAC 3123
1 x 4-5/8
Page 33

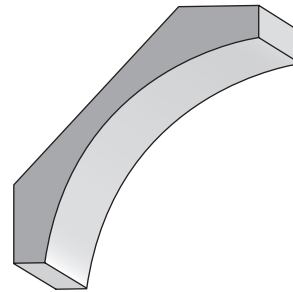

PAC 3124
7/8 x 3-1/2
Page 33

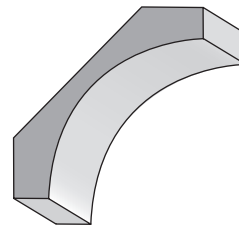

PAC 3125
7/8 x 4-7/16
Page 30

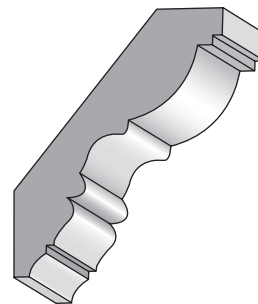

PAC 3126
13/16 x 3-11/16
Page 30

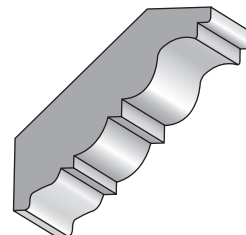

PAC 3127
3/4 x 3-11/16
Page 30

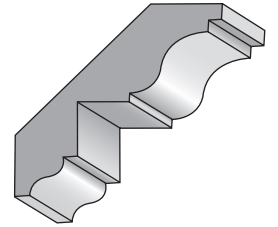

PAC 3128
1-5/16 x 1-9/16
Page 32

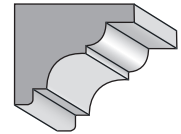

PAC 3129
7/8 x 3-1/2
Page 32

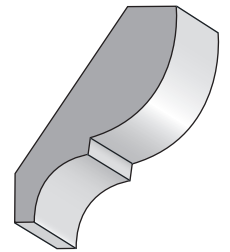

PAC 3130
1/2 x 5-1/4
Page 34

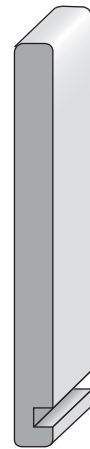

PAC 3131
1/2 x 3-1/4
Page 34

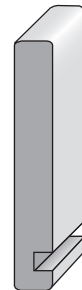

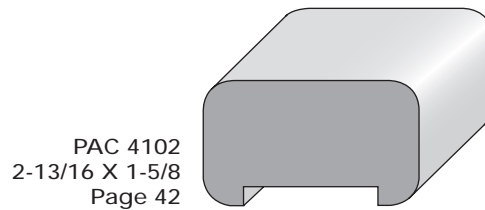
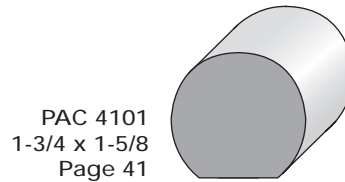
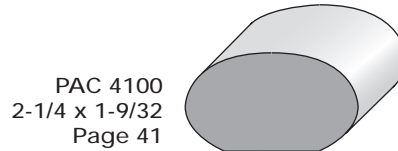
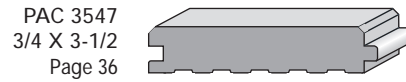
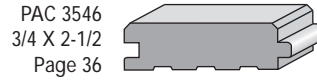
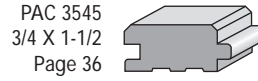
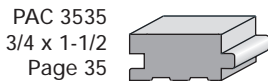
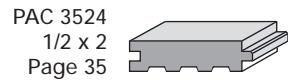
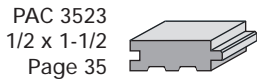
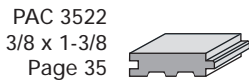
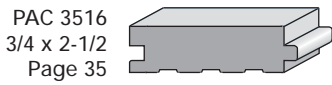
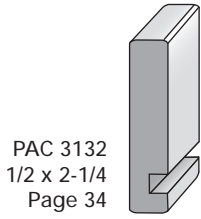



PAC 4103
2-1/2 X 1-3/4
Page 42

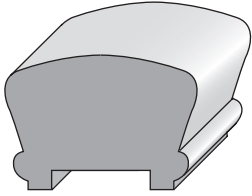

PAC 4104
2-5/16 x 1-1/2
Page 41

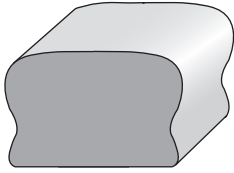

PAC 4105
1-5/8 x 2-13/16
Page 41

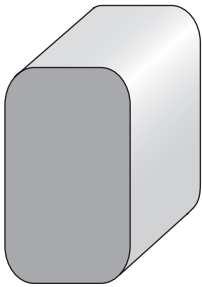

PAC 4106
2-3/8 X 2-1/4
Page 42

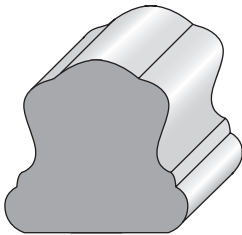

PAC 4107
2-1/4 X 2-3/8
Page 43

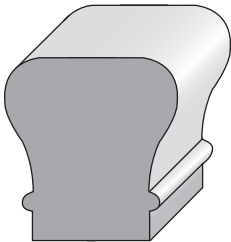

PAC 4109
2-3/4 X 2-1/4
Page 44

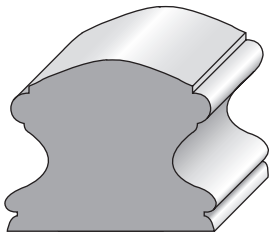

PAC 4110
2 X 2-5/16
Page 44

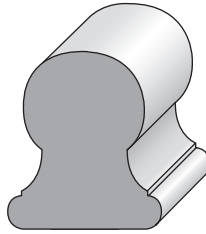

PAC 4111
2-1/2 X 2-5/16
Page 44

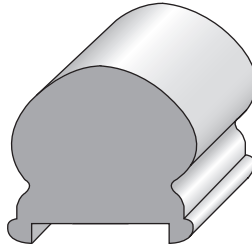

PAC 4112
2-5/8 X 3
Page 43

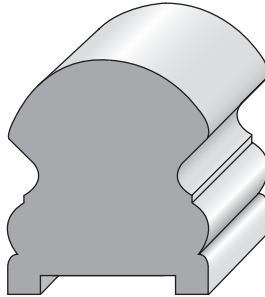

PAC 4113
1-5/8 X 5-1/2
Page 45

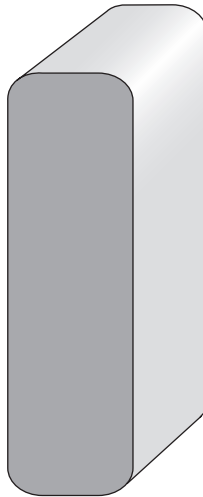

PAC 4114
1-5/8 X 5-1/2
Page 45

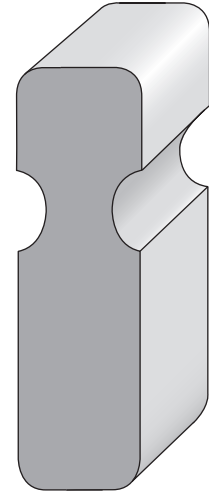

PAC 4611
3/8 x 1-1/4
Page 46

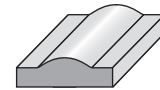

PAC 4612
3/4 x 2-1/2
Page 46

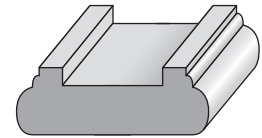

PAC 4613
1/4 x 1-3/4
Page 46

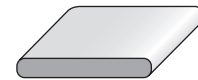

PAC 4614
1 x 3-1/8
Page 46

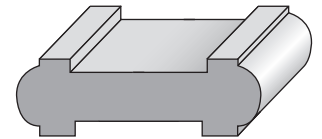

PAC 5100
1 x 3-1/2
Page 52

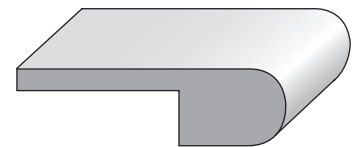

PAC 5101
1 x 3-1/2
Page 52

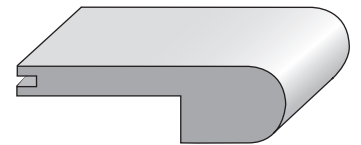

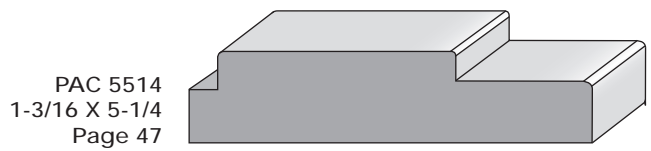
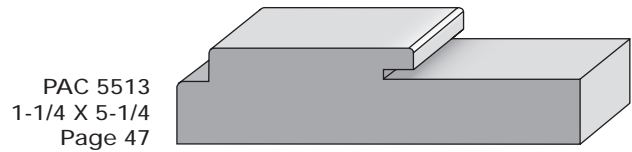
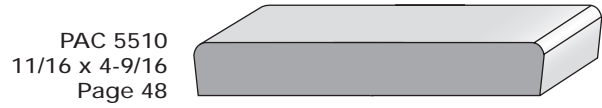
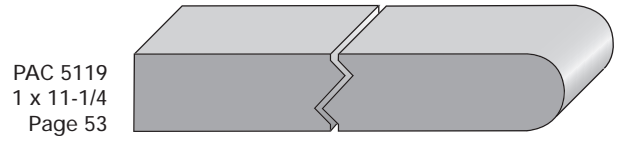
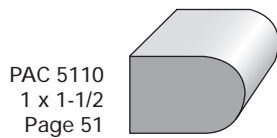
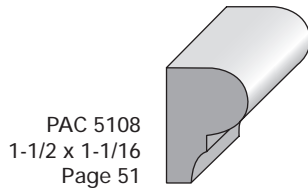
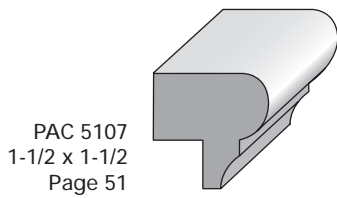
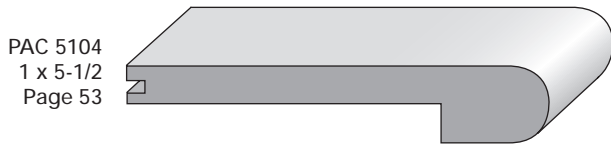
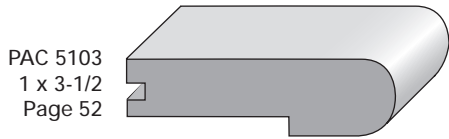
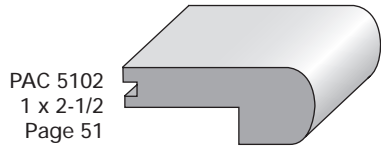



PAC 6101
3/4 x 2-5/8
Page 14



PAC 6102
5/8 x 2-1/2
Page 15



PAC 6103
5/8 x 3
Page 18

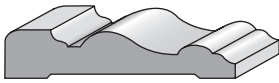

PAC 6104
3/4 x 3
Page 18



PAC 6105
1 x 2-1/2
Page 16



PAC 6106
1 x 3-1/2
Page 19

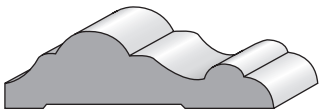

PAC 6107
1-1/4 x 2-1/2
Page 15

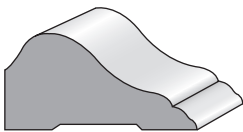

PAC 6108
11/16 x 3
Page 17



PAC 6110
3/4 x 2-7/8
Page 16

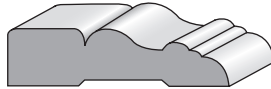

PAC 6112
1 x 1-7/8
Page 14

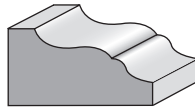

PAC 6113
1-3/16 x 3-13/16
Page 20

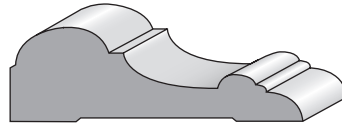

PAC 6114
11/16 x 2-1/4
Page 14

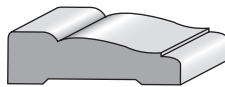

PAC 6115
11/16 x 2-7/16
Page 14

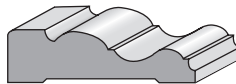

PAC 6116
3/4 x 3-1/4
Page 17



PAC 6117
1 x 3-1/4
Page 16



PAC 6118
11/16 x 2-1/4
Page 14



PAC 6119
11/16 x 2-7/8
Page 16



PAC 6120
3/4 x 2-1/2
Page 16

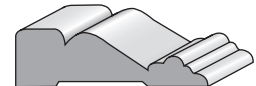

PAC 6121
1 x 3-1/2
Page 19

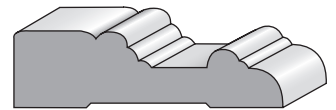

PAC 6122
3/4 x 3-1/4
Page 17



PAC 6123
7/8 x 3-3/4
Page 19

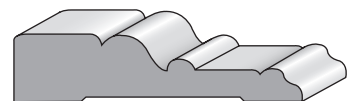

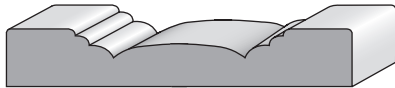
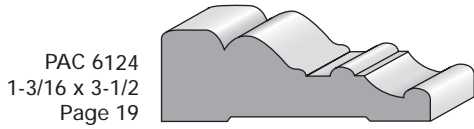

PAC 6126
3/4 x 4-1/2
Page 20



PAC 6125
9/16 x 5-1/2
Page 38

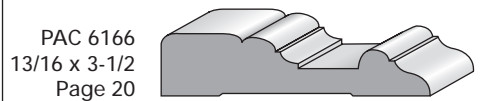
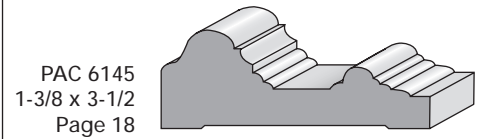
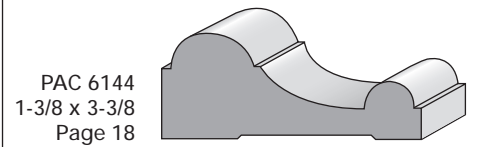
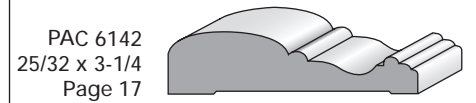
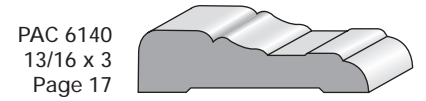
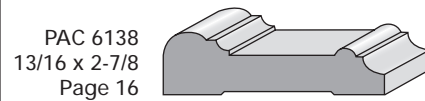
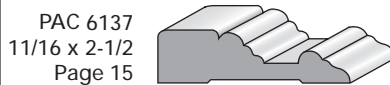
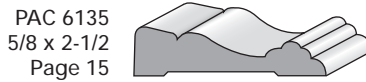
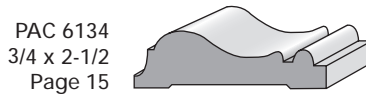
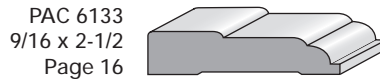
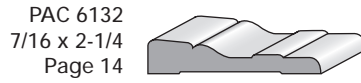
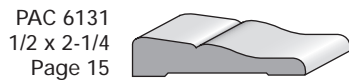
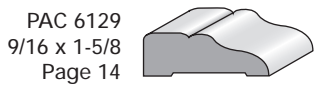
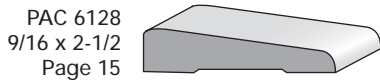
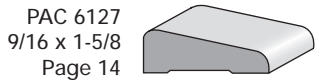



PAC 6167
1/2 x 3-1/2
Page 37

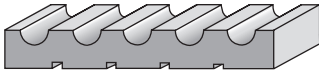

PAC 6188
1/2 x 2-1/2
Page 38

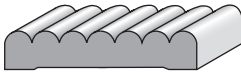

PAC 6189
3/4 x 3
Page 37

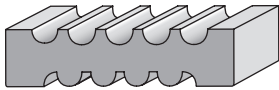

PAC 6190
1-1/8 x 5-1/8
Page 38

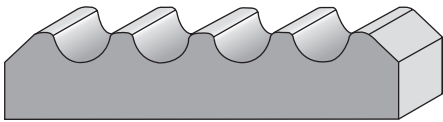

PAC 6191
1-5/16 x 5-1/4
Page 39

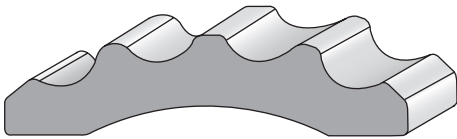

PAC 6192
11/16 x 5-1/2
Page 39



PAC 6193
11/16 x 3-1/2
Page 37

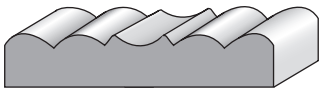

PAC 6510
3/4 x 4-1/2
Page 23

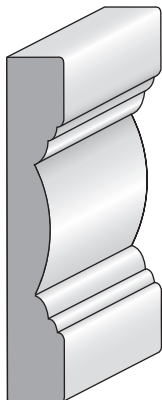

PAC 6511
13/16 x 2-7/8
Page 22

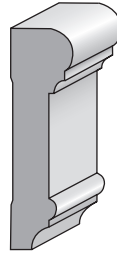

PAC 6512
9/16 x 2-3/4
Page 21

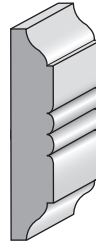

PAC 6513
3/4 x 3
Page 22

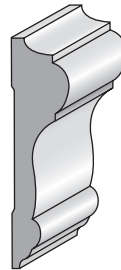

PAC 6514
5/8 x 2-5/8
Page 22

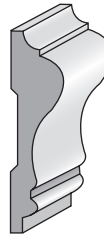

PAC 6517
13/16 x 2-3/8
Page 23

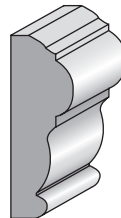

PAC 6518
11/16 x 2-3/16
Page 21

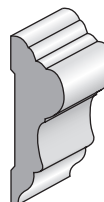

PAC 6519
7/16 x 2
Page 21

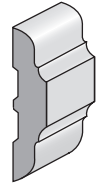

PAC 6520
11/16 x 1-5/8
Page 21

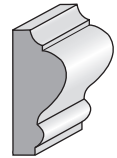

PAC 6521
5/8 x 1-5/8
Page 21

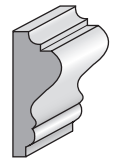

PAC 7100
9/16 x 1-1/8
Page 13

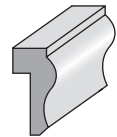

PAC 7101
7/16 x 1-3/8
Page 13



PAC 7102
3/4 x 1-1/2
Page 13

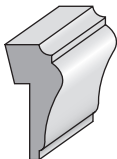



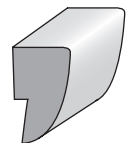

PAC 7103
3/4 x 1-1/4
Page 13

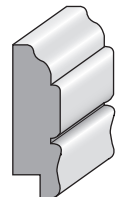

PAC 7104
5/8 x 2
Page 13

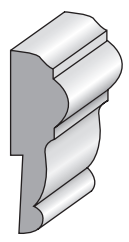
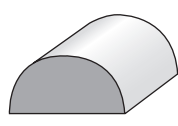
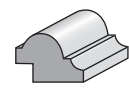
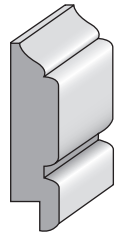
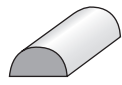
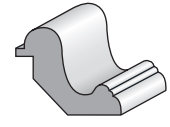
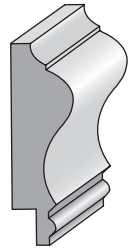
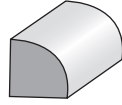
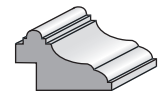
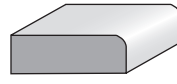
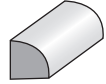
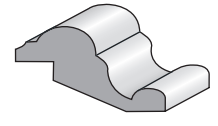
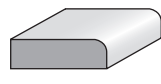

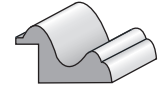
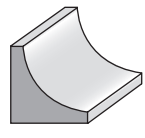

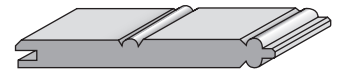
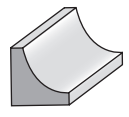
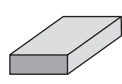
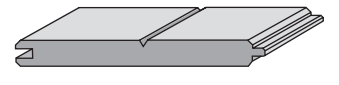
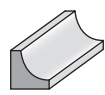
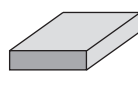
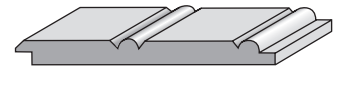
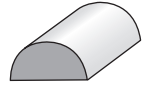
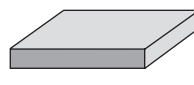
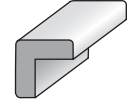
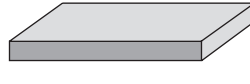
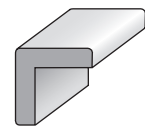
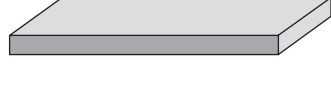
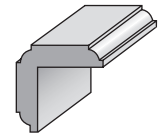
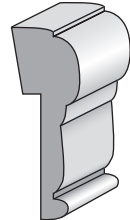
<p>PAC 7105 3/4 x 2-3/8 Page 13</p>		<p>PAC 7516 3/4 x 1-1/2 Page 40</p>		<p>PAC 8102 5/8 x 7/8 Page 54</p>	
<p>PAC 7106 5/8 x 2-7/16 Page 13</p>		<p>PAC 7517 3/8 x 3/4 Page 40</p>		<p>PAC 8103 1-1/8 x 1-5/16 Page 12, 54</p>	
<p>PAC 7107 13/16 x 2-5/8 Page 13</p>		<p>PAC 7518 3/4 x 3/4 Page 24</p>		<p>PAC 8104 25/32 x 1-1/4 Page 54</p>	
<p>PAC 7510 1/2 x 1-1/2 Page 49</p>		<p>PAC 7519 1/2 x 1/2 Page 24</p>		<p>PAC 8105 3/4 x 2 Page 12, 54</p>	
<p>PAC 7511 3/8 x 1-1/4 Page 49</p>		<p>PAC 7520 3/8 x 3/8 Page 24</p>		<p>PAC 8110 3/4 x 1-1/4 Page 54</p>	
<p>PAC 7512 1 x 1 Page 24</p>		<p>PAC 7521 1/4 x 1/4 Page 24</p>		<p>PAC 8510 3/8 x 3-3/8 Page 61</p>	
<p>PAC 7513 3/4 x 3/4 Page 24</p>		<p>PAC 7901 1/4 x 3/4 Page 50</p>		<p>PAC 8511 11/32 x 3-1/4 Page 61</p>	
<p>PAC 7514 1/2 x 1/2 Page 24</p>		<p>PAC 7902 1/4 x 1 Page 50</p>		<p>PAC 8512 5/16 x 3-3/8 Page 61</p>	
<p>PAC 7515 1/2 x 1 Page 40</p>		<p>PAC 7903 1/4 x 1-3/4 Page 50</p>		<p>PAC 9510 3/4 x 3/4 Page 24</p>	
		<p>PAC 7904 1/4 x 2-1/2 Page 50</p>		<p>PAC 9511 1 x 1 Page 24</p>	
		<p>PAC 7905 1/4 x 3-1/2 Page 50</p>		<p>PAC 9512 1-1/8 x 1-1/8 Page 24</p>	
		<p>PAC 8100 7/8 x 2-1/2 Page 55</p>			



pacificHARDWOOD

We Measure Up

Radius Moulding Sections/ Flexible Moulding

Pacific Hardwood provides moulding solutions for curved and radius corners. Curved radius sections of any of our moulding profiles can be manufactured from your template or from data supplied regarding your configuration. Please refer to the facing page for specific required measurements. Standard bullnose corners and interior corners are available for standard 5/8" radius walls. Length sections of flexible base moulding are available in 6' and 12' lengths. Contact our sales department for details.

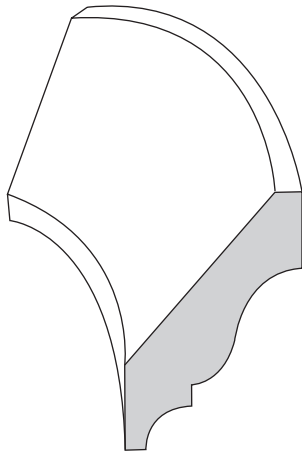

Radius sections of moulding can be produced from your template or specifications.

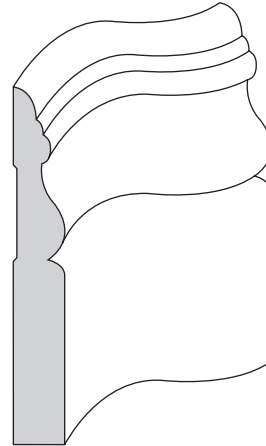

Lengths of flexible moulding are available.

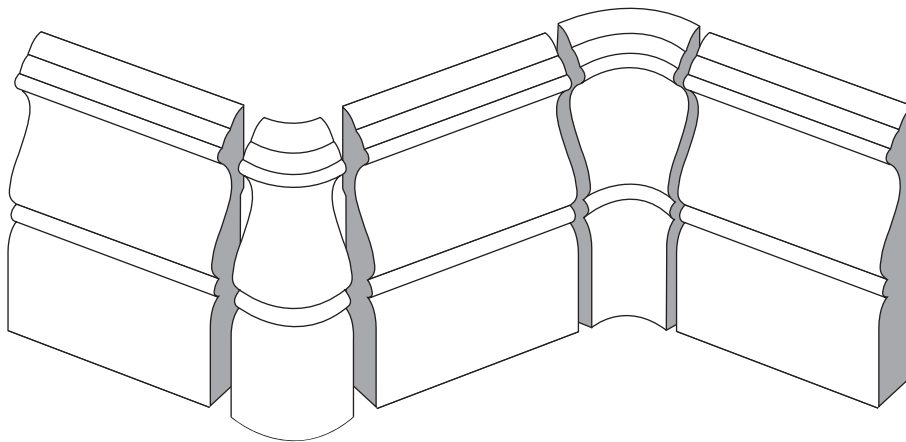

Inside and outside corners are available for radius walls.

Radius Moulding Section Required Information

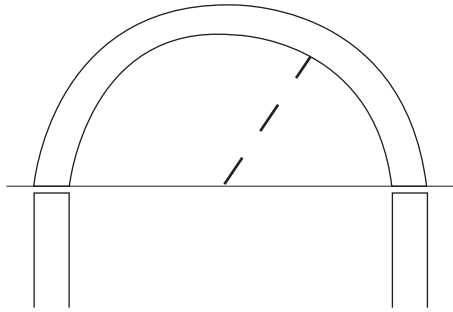

Arched casing moulding headers are produced from the interior diameter of the radius arch.

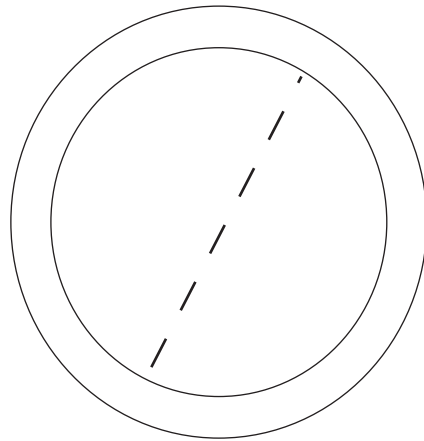

Circular mouldings are manufactured from the required interior diameter.

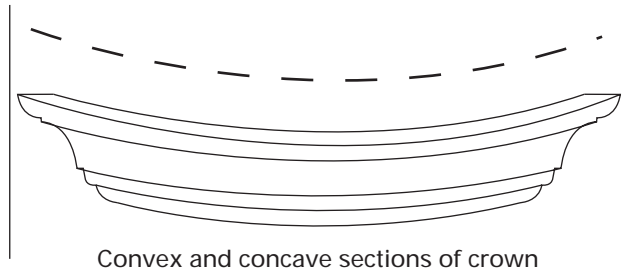

Convex and concave sections of crown moulding are manufactured from a template of the wall curve.

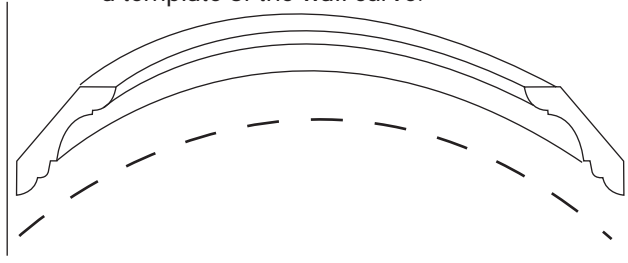

REQUEST FOR MOULDING QUOTATION

To obtain a quotation on a moulding detail,
fax this completed form to 714.998.6260

CUSTOMER INFORMATION:

<u>Company</u>		
<u>Address</u>		
<u>City</u>	<u>State</u>	<u>Zip</u>
<u>Phone</u>	<u>Fax</u>	
<u>Contact</u>		

Detail overall size (for example 3/4" x 2-1/2"):

Type of Profile (base, crown, for example)

Drawing or Sample Supplied:

Lumber Species:

Other Specifications:

Random Lengths or Specified Lengths:

Required Quantity:

Required Date for Shipment:

Delivery or Will-Call:

Do you have a fork lift:

Your business hours:

PH 714.998.6446
FX 714.998.6260